



**REPUBLIC OF NAMIBIA**

---

**LAW REFORM AND DEVELOPMENT COMMISSION**

---

**REPORT ON**  
**SUCCESSION AND ESTATES**

(Project 6)

**LRDC 20**

**July 2012**

**Windhoek, Namibia**

**ISSN 1026-8405**

**ISBN 978-99945-0-054-3**



**REPUBLIC OF NAMIBIA**

---

**LAW REFORM AND DEVELOPMENT COMMISSION**

---

**REPORT ON**  
**SUCCESSION AND ESTATES**

(Project 6)

**LRDC 20**

**July 2012**

**Windhoek, Namibia**

**ISSN 1026-8405**

**ISBN 978-99945-0-054-3**

## PUBLICATIONS OF THE LRDC

### **ANNUAL REPORTS (ISSN 1026-8391)\***

First Annual Report – 1992 (ISBN 0-86976-382-2)  
Second Annual Report – 1993 (ISBN 0-86976-383-0)  
Report on Activities from 1994 to 2002 (ISBN 0-86976-604-X)  
Annual Report – 2003 (ISBN 0-86976-643-0)  
Annual Report – 2004 (ISBN 0-86976-667-8)  
Annual Report – 2005 (ISBN 0-86976-700-3)  
Annual Report – 2008 (ISBN 0-86976-790-0)

### **OTHER PUBLICATIONS (ISSN 1026-8405)\***

- LRDC 1 Aspects of Family Law: The Abolition of Marital Power and Equalization of Rights between Spouses (ISBN 0-86976-384-9)
- LRDC 2 The Ascertainment of Customary Law and the Methodological Aspects of Research into Customary Law: Proceedings of Workshop, February/ March 1995 (ISBN 0-86976-385-7)
- LRDC 3 T.W. Bennett, Customary Law and the Constitution, October 1996 (ISBN 0-86976-397-0)
- LRDC 4 Report on the law pertaining to Rape (ISBN 0-86976-406-3)
- LRDC 5 Report on Maintenance (ISBN 0-86976-407-1)
- LRDC 6 Report on Small Claims Courts (ISBN 0-86976-412-8)
- LRDC 7 Violence against and Abuse of Women and Children Project: Formal Addresses made at the National Hearing-May 1997 (ISBN 0-86976-412-6)
- LRDC 8 Violence against and Abuse of Women and Children Project: Verbatim Discussions held at the National Hearing-May 1997 (ISBN 0-86976-490-X)
- LRDC 9 Domestic Violence Cases reported to the Namibian Police – Case Characteristics and Police Responses (ISBN 0-86976-516-7)
- LRDC 10 Report on Domestic Violence (ISBN 0-86976-555-8)
- LRDC 11 Report on Uniform Consequences of Common Law Marriages (Repeal of Section 17(6) of Native Administration Proclamation, 1928 (Proclamation 15 of 1928) (ISBN 999916-63-57-6)
- LRDC 12 Report on Customary Law Marriages (ISBN 0-86976-651-1)
- LRDC 13 Report on Divorce (ISBN 0-86976-654-6)
- LRDC 14 Report on Public Gatherings (ISBN 0-86976-689-9)
- LRDC 15 Report on Marital Property (ISBN 978-0-86976-793-1)
- LRDC 16 Report on Publications (ISBN 978-0-866976666-792-4)
- LRDC 17 Report on Adjustment of Fines (ISBN 978-0-86976-791-7)
- LRDC 18 Further Report on Rape (ISBN 978-99945-0-052-9)
- LRDC 19 Electoral Law Reform Project: Revision and Reform of the Namibian Electoral Act, 1992 (Act No. 24 of 1992) (ISBN 978-99945-0-053-6)

**\*Number of publication, ISSN and ISBN numbers not printed on all copies.**



## REPUBLIC OF NAMIBIA

---

# LAW REFORM AND DEVELOPMENT COMMISSION

---

Tel.: (061) 228593  
Fax: (061) 240064  
E-mail: [lawreform@moj.gov.na](mailto:lawreform@moj.gov.na)  
Enquiries: The Secretary

Private Bag 13302  
Windhoek

Hon. Mrs Pendukeni Iivula-Ithana, MP  
The Minister of Justice  
Windhoek

Dear Honourable Minister,

### **Statutory Submission of the Report on Succession and Estates by the Law Reform and Development Commission**

1. The Law Reform and Development Commission (LRDC) is obliged to report to the Minister of Justice for consideration pursuant to section 9(1) of the Law Reform and Development Commission Act, 1991 (Act No. 29 of 1991) [as amended] in regard to any matter examined by it.
2. It is therefore my privilege as Chairperson of the LRDC to present to you this Report on Succession and Estates, and in doing so, thank the previous Commissioners of the LRDC, stakeholders and the staff involved in bringing about this report for their inputs.
3. The LRDC will avail itself to assist the Minister in the consideration of the contents of the Report on Succession and Estates.

Sincerely

**Sacky Shanghala**  
**CHAIRPERSON**

**July 25, 2012**

# LAW REFORM AND DEVELOPMENT COMMISSION

The Namibian Law Reform and Development Commission (the LRDC) is a creature of statute established by **Section 2** of the **Law Reform and Development Commission Act, 1991 (Act No. 29 of 1991)**.

The core mandate of the Commission is to undertake research in connection with all branches of law and to make recommendations for the reform and development thereof.

The members of the LRDC on 1 August 2010 were:

Mr J R Walters, Ombudsman (Acting Chairperson)

Dr S Akweenda

Mr A Denk

Ms B Burger

Ms T Hancox

Ms N Shivute

Mr F Nghiishililwa

The current Commission members are–

Mr S Shanghala, Chairperson

Ms D Hubbard, Deputy Chairperson

Adv J Walters, Ombudsman

Mr M Frindt

Mr N Marcus

Ms D Muruko

Mr F Nghiishililwa

Mr R Rukoro

The Secretary to the Commission is Mr J.T. Namiseb who heads the Directorate of Law Reform, an organizational component in the Ministry of Justice. The Directorate of Law Reform serves as Secretariat to the Commission, assisting the Commission in the exercise of its powers and the performance of its duties and functions under the Act. The Secretariat is housed on the 2<sup>nd</sup> Floor, Mutual Platz Building, Post Street Mall, Windhoek.

All correspondence to the Commission should be addressed to:

The Secretary  
Law Reform & Development Commission  
Private Bag 13302  
Windhoek  
Republic of Namibia

Fax: (+264-61) 240064  
Tel.: (+264-61) 228593  
E-mail: [lawreform@moj.gov.na](mailto:lawreform@moj.gov.na)

# CONTENTS

	<b>Page</b>
1. Introduction and Background	1
2. Activities of the Commission	3
3. Underlying Policies	5
4. Consideration and Recommendations	7
5. Annexure A: Intestate Succession Bill	14
6. Annexure B: Explanatory Notes for Intestate Succession	22
7. Annexure C: Draft Administration of Estates Amendment Bill	39
8. Annexure D: Berendt and Another v Stuurman and Others 2003 NR 81 HC	48
9. Annexure E: Estates and Succession Amendment Act, 2005 (Act No.15 of 2005) (Ordinance 12 of 1946)	61
10. Annexure F: Intestate Succession Ordinance, 1946 (Ordinance 12 of 1946)	65
11. Annexure G: Political Ordinance of 1 April 1580 (Articles 19-29)	66
12. Annexure H: Interpretation of 13 May 1594	68
13. Annexure I: Octrooi of 10 January 1661	69
14. Annexure J: Second schedule of the Rules of Intestate Succession Applicable to the Estates of Members of the Rehoboth Baster Community	70

## 1. INTRODUCTION AND BACKGROUND

1.1 The existing laws on inheritance violate the Namibian Constitution<sup>1</sup> on the grounds of *race* and *ethnic origin*. This is because under the old law there are different rules about inheritance for people of different races, depending on what part of Namibia they live in and what kind of marriage (customary or common law) they have entered into.<sup>2</sup>

1.2 The estates of *white*<sup>3</sup> people and *coloured*<sup>4</sup> people who die intestate (without leaving a will) follow a law called the *Intestate Succession Ordinance, 1946*. These estates are administered by the Master of the High Court.

1.3 The estates of *natives*<sup>5</sup> in some parts of Namibia and natives who have some types of marriages follow the same rules as the estates of white people and are

---

<sup>1</sup>Article 10 of the Namibian Constitution is worded as follows:

- (1) All persons shall be equal before the law.  
~~(2) No persons shall be discriminated against~~  
(2) No persons may be discriminated against the grounds of sex, race, colour, ethnic origin, religion, creed or social or economic status.”

<sup>2</sup> It should be noted that the use of any racial tag or term (utilized in the past to identify people) is for the sole purpose of recording the law and terms utilized under such laws.

<sup>3</sup>The legal definition of this term can be found under section 1(xv) of the Population Registration Act, 1950 (Act No. 30 of 1950) which defines a *white person* as:

“a person who in appearance obviously is, or who is generally accepted as a white person, but does not include a person who, although in appearance obviously a white person, is generally accepted as a coloured person.”

<sup>4</sup>This term is defined legally under section 1 of the Coloured Persons in South-West Africa Education Act, 1972 (Act No. 63 of 1972) as:

“a person who in fact is or is generally accepted as a member of the coloured population group of the territory.”

<sup>5</sup>Section 25 of the Native Administration Proclamation, 1928 (Proc. No. 15 of 1928 contains the following definition:

“ “native” shall include any person who is a member of any aboriginal race or tribe of Africa: Provided that any person residing in an area defined under paragraph (c) of section *one* of this Proclamation or set aside as a native reserve under section *sixteen* of the Native Administration Proclamation 1922 (Proclamation No. 11 of 1922), or in any native location, under the same conditions as a native shall be regarded as a native for the purposes of this Proclamation;”

The use of this term in this publication and related LRDC documents is therefore as a result of direct reference to a legal provision still applicable by virtue of Article 140 of the Namibian Constitution. The word *black* has a corresponding meaning with *native* if regard is had to the definition contained under section 35 of the Black Administration Act, 1927 (Act No. 38 of 1927) which states that black includes:

“any person who is a member of any aboriginal race or tribe of Africa.”

There is no evidence that the Black Administration Act, 1927 (Act No. 38 of 1927) did not apply to the territory already governed by/under the Union by virtue of earlier legislation such as the Treaty of Peace and South West Africa Mandate Act, 1919 (Act No. 49 of 1919).

administered by the Master of the High Court. The estates of native people in other parts of Namibia follow customary law. These estates were administered by magistrates before 2005.

1.4 The estates of people who are members of the *Rehoboth Baster*<sup>6</sup> community are administered under a different system and by different officials.

1.5 In the case of *Berendt and Another v Stuurman and Others*,<sup>7</sup> it was ordered that several sections of the *Native Administration Proclamation, 1928* (Proc. No. 15 of 1928) are unconstitutional violations of the prohibition on racial discrimination in terms of Article 10 of the Namibian Constitution.

1.6 These complicated provisions treated the estates of deceased black as if they were “*Europeans*” in some circumstances, while requiring in other circumstances that they should be distributed according to “*native law and custom*”. The *Berendt* case also struck down the legal provision which gives magistrates power to administer “black estates” while other estates go to the more specialized jurisdiction of the Master of the High Court. Parliament was given a deadline of 30 June 2005 to replace these offensive sections with a new system. This deadline was extended to 31 December 2005 in *Government of the Republic of Namibia v The Master of the High Court & 3 Others*.<sup>8</sup>

1.7 In compliance to the Court’s directive, the Succession and Estates Amendment Act, 2005 (Act No. 15 of 2005) was enacted to take away the discriminatory provisions. There is however a need to reform the system further.

---

<sup>6</sup>This term is defined under section 1 of the Bastards of Rehoboth Education Act, 1972 (Act No. 85 of 1972). Section 29 of the Administration of Estates (Rehoboth Gebiet) Proclamation, 1941 (Proc. No. 36 of 1941) describes *Rehoboth Baster* as follows:

“Member of the Rehoboth Bastard Community” shall mean and include any person who, by reason of his birth or parentage. Possesses full burgher rights in the Gebiet under the laws and Constitution of the Rehoboth Bastard Community. Or any non-European person whose application to be accepted as a burgher of the Gebiet has been approved in accordance with the laws and constitution of the Rehoboth Bastard Community, or the wife of any born or accepted burgher, or any legitimate child of any parents both of whom are members of the Rehoboth Bastard Community as aforesaid, or any illegitimate child whose mother is a member of the Rehoboth Bastard Community as aforesaid.”

<sup>7</sup>2003 NR 81 HC.

<sup>8</sup>Unreported Case No 105/2003.



1.8 Since its establishment in 1991, the Law Reform and Development Commission (hereinafter referred to as the *LRDC* or the *Commission*) of course gave general attention to the broader field of family law as well as of customary law.

1.9 For practical purposes the Commission identified matters that need(ed) special priority attention and narrowed its focus to such matters through establishing separate specific projects for such matters.

1.10 One of those matters is that which is now being dealt with under this *Succession and Estates Report*. The project culminating into this Report has been numbered as Project 6 and was also known at some stages in the past as the "Inheritance" Project.

## **2. ACTIVITIES OF THE COMMISSION**

2.1 The Commission finds it relevant to highlight the activities which have occurred, and which have a bearing to customary law under its auspices:

- a. In March 1995 the Commission, with the very generous support from the then Deutsche Gesellschaft für Technische Zusammenarbeit GmbH (GTZ), held a workshop on *The Ascertainment of Customary Law and the Methodological Aspects of Research into Customary Law*. Papers on various topics were delivered by eminent participants from Namibia and the Southern African region as well as from the United Kingdom. Thereafter, the Commission published in this regard The Ascertainment of Customary Law and the Methodological Aspects of research into Customary Law: Proceedings of Workshop.<sup>9</sup>
- b. The Commission, with the assistance of the GTZ, also commissioned an expert on customary law, Professor T W Bennett, who compiled a *Background and Discussion Paper on Customary Law and the Constitution*.<sup>10</sup>
- c. The Commission, during the late 1990's embarked on some field research under the leadership of Dr M Rüniger, Chief Technical Advisor of the Legal Capacity

---

<sup>9</sup>This publication was published during February/March 1995 (ISBN 0-86976-385-7),LRDC 2.

<sup>10</sup>This publication was published 1996, (TW Bennett; October 1996) [ISBN 0-86976-397-0], LRDC 3.

Building Programme of the GTZ, which was attached to the Law Reform and Development Commission. This project was completed with the assistance of law students from the University of Namibia's Law Faculty, many of whom are now staff members of the Ministry of Justice, including the current Chairperson of the LRDC.

- d. For some time during 1998/1999 a Committee of the Commission gave attention to this matter. Apart from the Commissioners, staff members of the Ministry of Justice, Dr Runger, Mr C Light of the Legal Assistance Centre (LAC) and Dr N Nghifindaka of the then Department of Women Affairs, in the Office of the President served on the Committee.

2.2 It must be pointed out that the area of the law covered by this project is extremely broad and fundamental to the Namibian society. The theme of the project deals with very controversial issues. The Commission has received requests, comments, proposals and input from a vast number of persons and bodies over the years.

2.3 It is not the purpose of this document to record all such contributions. Neither does the report document the detailed scope of the Commission's activities, its research in this regard and the persons and bodies involved in it. It should however, for the record, be stated that during consultations with traditional leaders over the past two years by the Chairperson and staff members of the Commission, which consultations were primarily for the sake of the Commission's Project on Customary Law Marriages, the broader issues pertaining to Succession and Estates were regularly raised and discussed. Further and more focused consultations were conducted with the traditional leaders during July 2010. Additional consultations will be held during 2013.

2.4 Quite a lot of material was collected during the consultative period. However, the Commission will only concentrate on what it regards as necessary for the purposes of motivating amending legislation to Parliament. With a view of the above intention, the Commission has decided to keep the format of this document as simple as possible.

2.5 It is incontrovertible that Namibia and South Africa share in common a similar social and legal history persisting. It is even more profound with regard to matters

of succession and estates. Therefore, material prepared in the Republic of South Africa in this regard, (e.g. academic articles in journals, judgments, papers issued by the South African Law Reform Commission) are very relevant for Namibia.

2.6 The basis for the above contention is that the statutory and common law of the Republic of Namibia was developed under the law of the Republic of South Africa until independence in 1990. The lasting effects of the development of the law pre 1990 binds law reform path of the two countries together in that solutions to these matters in Namibia may find applicability in South Africa and *vice versa*.

### 3. UNDERLYING POLICIES

3.1 It is required that few underlying policies be highlighted.

3.2 The Commission has decided to accept the general approach of the Administration of Estates Act, 1965 (Act No. 66 of 1965) for the handling of estates. This means that the (English) system of executorship,<sup>11</sup> and not the (Romanistic/Continental/German) system of universal succession,<sup>12</sup> is accepted.

3.3 The Commission is satisfied that to follow a new system would result in the moving away from a well-established system (part of the Common law) with practices entrenched in societal conduct when faced with the death of loved ones, which the Commission views will indirectly cause more confusion and harm than intended.

3.4 The development and implementation of such a new system will require expertise that Namibia doesn't have and might not afford. In any event, it seems that the

---

<sup>11</sup>Under this system, the executor is the intermediary between the beneficiaries and the deceased. The executor takes charge of the estate and executes his/her functions under the auspices of the Master of the High Court under law. The executor may be assisted by administrator in the winding up of the estate.

<sup>12</sup>Prof Konrad Osajda in his paper titled *An Overview Of Fundamental Principles Of Polish Succession Law In The Light Of Eventual Unification Of Succession Law In The European Union* defines this system accordingly:

“According to the universal succession principle, successors acquire an entire estate at the moment of death of the person who left them the estate (either according to the last will – testacy or according to statutory rules – intestacy). The acquisition of all of the rights and duties included in the estate does not require the completion of any formalities. It happens exactly at the moment of the opening of the inheritance (the inheritance opens at the moment of death); even if successors do not know that they were appointed (for example when the last will was not found at that moment). The acquisition of the estate by successors is automatic...”

This is an explanation of what is contained in the German inheritance rules CC § 1922(1). The paper can be accessed and viewed at the following address:

[http://www.pels.edu.pl/files/Conference%20Proceedings/Rigas/Konrad%20Osajda\\_An%20Overwiew%20of%20Fundamental%20Principles%20of%20Polish%20Succession%20Law%20in%20Light%20of%20Eventual%20Unification.pdf](http://www.pels.edu.pl/files/Conference%20Proceedings/Rigas/Konrad%20Osajda_An%20Overwiew%20of%20Fundamental%20Principles%20of%20Polish%20Succession%20Law%20in%20Light%20of%20Eventual%20Unification.pdf), last viewed on July 16, 2012.

serious problem of "property-grabbing"<sup>13</sup> can also best be dealt with by the executorship system. This does not mean that the Commission recommends unnecessary bureaucratic procedures for small estates.

3.5 The Law of Succession deals with personal law and the Commission is not able to adopt a single system. The consultations have indicated the conflicting positions between customary law based rules of intestate succession, on the one hand, and the common law based rules of succession, on the other. The Commission will advance three positions as part of its recommendations.

3.6 The Commission, in its wisdom, has resolved that Namibia cannot do away altogether with customary law in this regard. The estates of persons who still have very close connections with their customary law and their traditional communities and leaders should and can be handled in accordance with customary law, with some improvements.<sup>14</sup>

3.7 It is the Commission's opinion, that it will not codify the entire law of succession. However, the basic law of intestate succession is codified. In this regard, the Commission could rely on work done in South Africa. It is very difficult to separate the core principles of succession from related aspects and at any attempt to codify this law the scope of such codification simply broadens.

3.8 Codifying the common law, in particular when dealing with such very complicated matters as succession requires exceptional expertise in the subject itself as well as in legal drafting - and it can hardly be separated. The Commission in due course realized that, for the sake of progress, it should not try to do too much at once.

3.9 Immediate follow up to this project is very essential, and the Wills Act, 1953 (Act No. 7 of 1953) as well as the Administration of Estates Act, 1965 (Act No. 65 of 1965) will be prioritized and addressed in the term of this Commission.

---

<sup>13</sup>The convenient description of forceful dispossessions of inherited assets from lawful beneficiaries by more powerful relatives.

<sup>14</sup> In this regard the South African Law Reform Commission's Report on Customary Law of Succession (Project 90) may prove to be a useful guide for Namibia.

## 4. CONSIDERATION AND RECOMMENDATIONS

4.1 The consultative sessions brought to light a number of fundamental basic issues, which have been considered by the Commission. The recommendations that follow have been distilled from those fundamental issues.

4.2 The enactment of the Succession and Estates Amendment Act, 2005 (Act No. 15 of 2005) was an attempt at removing the race-based discrimination, which was legally introduced into the process of the administration of Estates.<sup>15</sup> However, a number of problems still call for reform. These are dealt with hereunder:

### 4.3 Basic Principles

The Commission has considered a range of options for reform. The Legal Assistance Centre (LAC) has also put forward some recommendations based on its research in several regions of the country. Most of the options for a new law on inheritance have some principles in common, namely:

- (i) Unconstitutional aspects of the law on inheritance must be changed;
- (ii) Where people execute (make) wills, their wishes should generally be respected – although it would be possible to apply part of the estate to provide maintenance for the deceased’s dependents before looking to the will;
- (iii) The laws on inheritance should make sure that the deceased’s spouse and children are provided for in some way; and

---

<sup>15</sup> The relevant provisions of the Succession and Estates Amendment Act, 2005 provides as follows:

*“1. (1) Section 18 of the Native Administration Proclamation, 1928 is amended by the repeal of subsections (1), (2), (9) and (10).*

*(2) Despite the repeal of the provisions referred to in subsection (1), the rules of intestate succession that applied by virtue of those provisions before the date of their repeal continue to be of force in relation to persons to whom the relevant rules would have been applicable had the said provisions not been repealed.*

*2. (1) The Administration of Estates (Rehoboth Gebiet) Proclamation, 1941 is repealed.*

*(2) Despite the repeal of the Proclamation referred to in subsection (1), the rules of intestate succession that applied by virtue of Schedule 2 of that Proclamation before the date of its repeal continue to be of force in relation to persons to whom the relevant rules would have been applicable had the said Proclamation not been repealed.”*

- (iv) Where the deceased was a man in a polygamous marriage and who died intestate, all of the wives should share in the estate.<sup>16</sup>

#### 4.4 Property-Grabbing

4.4.1 This practice has resulted in situations where many widows are denied access to the property of their late husbands.

4.4.2 In terms of this practice, which is often justified in terms of customary laws, the relatives of a deceased will take all the assets, which belonged to the deceased person and his spouse.

4.4.3 The Commission hopes that this report will assist in the elimination of this practice of *property-grabbing*.

4.5 Three possible avenues for a solution have emerged from the broad consultations with the stakeholders. These are:-

- a) Option 1 – Two Paths Solution;
- b) Option 2 – One Path for All; and
- c) Option 3 – Compromise Approach.

#### 4.5.1 Option 1

4.5.1.1 Option 1 advocates that there must be recognition of two types of estates namely Customary law estates and other estates.

(a) *Customary law estates* will be administered in terms of the relevant customary laws. Those aspects of the customary laws which are unconstitutional will however not be applied. Issues of discrimination against women, children born out of wedlock will be legislated against; and

---

<sup>16</sup> It should be understood that even if polygamy is outlawed in the future, there will still be wives married in polygamous customary marriages from the past who must be protected by law.

(b) *Other Estates* will be administered along the lines which have clearly defined beneficiaries. The estate will be inherited by the surviving spouse and failing such a spouse, it will go to the children of the deceased (those born in wedlock being treated similarly to those born out of wedlock). If there are no children, the estate will be inherited by the parents of the deceased and failing them, by the siblings of the deceased which will include half-siblings. If there are no brothers or sisters, then the estate will be inherited by other consanguine (blood) relatives.

#### 4.5.1.2 How to identify customary law estates

(a) The deceased person's wishes must be followed as far as it is known;

(b) Factors such as the lifestyle of the deceased should be considered. This includes the considerations like whether the deceased was in a customary marriage, and whether the deceased lived in a communal area; and

(c) The nature and value of the deceased estate will also be a guide.

#### 4.5.1.3 Support for this option

(a) This option attempts to dispose of the property in the way that the deceased would most likely have chosen had he or she made a will;

(b) This option respects culture by preserving customary law more than any other option; and

(c) This option is closest to the current practice, and is thus more likely to be followed without flaw in practice.

#### 4.5.1.4 Arguments against this option

- (a) This option fails to provide for a strong mechanism to prevent unconstitutional practices under customary law;
- (b) This option does not appear to give sufficient protection to spouses and children in the case of customary law estates; and
- (c) It will be difficult to identify customary law estates.

## 4.5.2 Option 2

4.5.2.1 This options advocates that the deceased estate should be inherited by spouses and children of the deceased persons. In terms hereof a half share should be inherited by the widow and the other half by the children. If there is no spouse and children, the estate will be inherited by the parents of the deceased. If there are no parents to inherit, the estate will go to the siblings and half-siblings of the deceased. In the absence of siblings, the estate will be inherited by other consanguine (blood) relatives.

### 4.5.2.2 Support for this option

- (a) All gender-based discrimination is done away in terms of this option;
- (b) This option gives strong protection to surviving spouses and children of a deceased person; and
- (c) There is no discrimination as all individuals in Namibia are treated exactly the same.

### 4.5.2.3 Arguments against this option

- (a) This option will overrule much of the customary law and as such might not be well received by traditional communities;



- (b) If people are unhappy about the law, property grabbing may escalate; and
- (c) This option might not protect all persons who were dependent on the deceased.

### 4.5.3 Option 3

4.5.3.1 This option aims to take a compromise approach by allocating a share of the estate to the *Spouse and Children* on the one hand and *Customary Heirs* on the other hand.

4.5.3.2 A fixed percentage of the estate must be allocated to the surviving spouse and the deceased's children (born in and out of wedlock) as priority heirs. A fixed percentage to heirs under customary law must also be provided. The applicable customary law provisions must not involve unconstitutional discrimination. If there are no spouses or children of the deceased, their share will be distributed as discussed in option 2.

4.5.3.3 This option will be combined with the provision for maintenance of the dependants of the deceased as well as legal provisions allowing the spouse(s) and children to remain in the marital home.

4.5.3.4 Support for this option

- (a) This option attempts to protect spouses and children while still maintaining the role of customary succession rules; and
- (b) The refusal of the state to enforce any unconstitutional aspects of customary law would allow for gradual evolution of customary laws in these areas.

4.5.3.5 Arguments against this option

- (a) A compromise approach might end up not satisfying anyone; and
- (b) It is arguably time for decisive statutory intervention.

- 4.5.3.6 Having considered all of the available options, the Law Reform and Development Commission recommend that Option 3 could provide the best possible solution to the current problems.
- 4.5.3.7 The Bill contained in Annexure A is based on the remedies to be provided under option 3.

This page intentionally left blank

## **INTESTATE SUCCESSION BILL**

**To regulate the law relating to intestate succession and to provide for matters connected therewith.**

*(Introduced by the Minister of Justice)*

**BE IT ENACTED** by the Parliament of the Republic of Namibia as follows:-

### **INTERPRETATION**

**1.** In this Act, unless the context otherwise requires -

“ascendants” mean the persons from whom the deceased person descended and include parents, grand-parents and great-grandparents;

"child" means a child born in, or out of marriage, including a marriage under Customary law, and an adopted child, and for the purposes of this Act, a child who is conceived but not yet born: Provided such child is subsequently born alive;

“collaterals” mean blood relations who are not ancestors or descendants but who are related to each other through a common ancestor, including but not limited to brother/sister, half brother/half sister, uncle/aunt, niece/nephew, cousins;

"Court" means the High Court of Namibia or any judge thereof;

“customary law” means the law, customs, norms, rules of procedure, traditions and practices observed among a traditional community in so far as they do not conflict with the provisions of the Namibian Constitution or any other statutory law applicable in Namibia;

"deceased" means a person who dies after the commencement of this Act;

"descendant" in relation to any person means the children and grandchildren of that person;

“estate” means all property, movable and immovable, and claims and transferable rights which belong to a deceased person but excludes property which

immediately before the death of a deceased was family or traditional property held in trust for the benefit of others in accordance with customary law and property which was institutionalised property of a traditional authority and had been acquired and was being held as part of the traditional authority's property;

“intestate estate” includes any property of a deceased person which does not devolve by virtue of a valid will;

“levirate marriage” means a marriage between a widow and the brother of the deceased;

“household effects” shall include, without being limited to, any furniture, furnishings, appliances, utensils, agricultural implements, tools, consumable stores or other things which a surviving spouse or child of the deceased was normally using in relation to the normal family home where that spouse or child resided immediately before the death of the deceased, but excludes items used primarily for business purposes, money or securities;

“priority dependant” means a spouse, child or parent of the deceased;

“sororate marriage” means a marriage between a widower and the sister of the deceased;

“spouse” means a person to whom the deceased was married at the time of his or her death including a person or persons to whom the deceased was married under customary law including a person in respect of whom some customary marriage rites have been performed but were incomplete at the time of the deceased’s death;

“will” means a will to which the provisions of the Wills Act, 1953 (Act No. 7 of 1953), apply.

## **APPLICATION**

2. (1) This Act shall apply to the estates of all persons who died after the commencement of this Act.
- (2) Only the deceased’s share of any marital property shall form part of the estate of the deceased.
- (3) If the deceased was married or separated, the Master shall not authorize the distribution of the estate until satisfied that all relevant property has been divided

according to the applicable marital property regime or any applicable agreement with respect to marital property.

## **INTESTATE SUCCESSION**

3. (1) If after the commencement of this Act a person (hereinafter referred to as the “deceased”) dies intestate, either wholly or in part, his or her estate shall be distributed among the heirs in the following manner, subject to section 5:
- (a) If the deceased is survived by one or more than one spouse, but not by a descendant, such spouse or spouses shall inherit the whole intestate estate of the deceased: Provided that where the deceased is survived by more than one spouse, who is entitled to inherit under this Act, such spouses shall share the estate in equal shares;
  - (b) If the deceased is survived by descendants, but not by a spouse, such descendants shall inherit the whole intestate estate *per stirpes*;
  - (c) If the deceased is survived by descendants and one spouse or more than one spouse, such spouse or spouses shall inherit one-half of the intestate estate of the deceased in equal shares or so much of the intestate estate of the deceased as does not exceed in value the amount fixed from time to time by the Minister of Justice by notice in the Gazette, whichever is the greater, and such descendants shall inherit the residue (if any) of the intestate estate of the deceased *per stirpes*.
  - (d) If the deceased is not survived by a spouse or descendant, but is survived:
    - i. by both his or her parents, his or her parents shall inherit the intestate estate in equal shares; or
    - ii. by one of his or her parents, the surviving parent shall inherit half of the intestate estate and the descendants of the deceased parent who have survived the deceased shall inherit the other half *per stirpes*; or
    - iii. if there are no such descendants who have survived the deceased, the surviving parent shall inherit the intestate estate.
  - (e) If the deceased is not survived by a spouse or descendant or parent, but is survived by
    - i. descendants of the deceased’s parents, the surviving descendants related to the deceased through the deceased’s mother shall inherit one half of the estate and the surviving descendants related to the deceased through the deceased’s father shall inherit the other half of the estate; or

- ii. only descendants of one of the deceased parents of the deceased who are related to the deceased through such parent alone, such descendants shall inherit the intestate estate.
- (f) If the deceased is not survived by a spouse, descendant, parent or a descendant of a parent,
- i. the other blood relation or blood relations of the deceased who are related to him or her nearest in degree, shall inherit the estate in equal shares; or
  - ii. if there is no such blood relation, the intestate estate shall be paid into the Guardian's Fund as contemplated in Chapter V of the Administration of Estates Act 1965 (Act No. 65 of 1965).
- (2) The degree of relationship between blood relations of the deceased and the deceased
- (a) in the direct line, shall be equal to the number of generations between the ancestor and the deceased or the descendant and the deceased (as the case may be);
  - (b) in the collateral line, shall be equal to the number of generations between the blood relations and the nearest common ancestor, plus the number of generations between such ancestor and the deceased.

#### **ADOPTED CHILDREN**

4. An adopted child shall be deemed -
- (a) to be a descendant of his or her adoptive parent or parents;
  - (b) not to be a descendant of his or her natural parent or parents or any previous adoptive parent or parents, except in the case of a natural parent who is also the adoptive parent of the child concerned or a natural parent who was married to the adoptive parent of the child concerned at the time of the adoption.

#### **CUSTOMARY LAW**

5. (1) An intestate estate will be distributed as contemplated in section 3 of this Act unless a certificate is issued by a Community Court and lodged with the Master stating that the deceased was either living at the time of his or her death in accordance with or closely connected to customary law, in which case the estate of the deceased will be distributed in accordance with this section.
- (2) The intestate estate of the deceased will devolve as follows:

- (a) eighty percent shall be distributed to the beneficiaries under section 3 of this Act and;
  - (b) twenty percent shall be distributed amongst customary law heirs who are not included in section 3 of this Act.
- (3)
- (a) Where this section is applicable, the executor of the estate shall draw up an inheritance plan providing for the distribution of the portion of the estate which falls under this section in terms of the applicable customary law, after consulting in so far as practical, with the deceased person's family and the beneficiaries.
  - (b) The executor shall submit the inheritance plan in the prescribed form to the Master for approval together with the liquidation and distribution account.
  - (c) Should it not prove possible to secure the agreement of the majority of the beneficiaries to the inheritance plan, the executor shall consult an appropriate Traditional authority for guidance in ascertaining the applicable customary law.
  - (d) The Traditional authority must provide such guidance in writing to the executor within thirty days from receipt of a request as provided for in subsection 5(3)(c).

## **FAMILY HOME**

- 6.
- (1) Notwithstanding the above and any valid will of the deceased, but subject to subsection (4) below, should the surviving spouse so desire and is not be financially able to afford to either rent or purchase a comparable residential property and is not the owner of residential property, the surviving spouse shall have a right of *usus* over the property owned by the deceased in which they normally resided as at date of death, together with the household effects therein, until his or her death or remarriage whichever is the sooner: Provided that such right of *usus* does not have preference over the rights of creditors against the estate.
  - (2) "Family home" shall include any property held by the deceased prior to death in terms of the Communal Land Reform Act 2002, Act No 5 of 2002 or any prior legislation, and in the event of any conflict, the provisions of this Act shall prevail.
  - (3) The right of *usus* must be registered against the property, other than property referred to under subsection (2), with the Registrar of Deeds by the executor or estate representative and proof thereof must be lodged with the Master.



- (4) Subsection (1) is subject to the surviving spouse assuming responsibility for payment of the rates and taxes, any other municipal services, any levies in respect of such property, insurance and the maintenance of the property.
- (5) The executor, estate representative or any interested person may apply to the Master to cancel the right of *usus* upon non-compliance with subsection (4).
- (6) The Master shall upon cancellation of the *usus* over immovable property instruct the Registrar of Deeds to cancel the right of *usus* registered against such property.
- (7) The rights conferred by subsection (1) shall—
  - (a) not derogate from or prejudice in any way the rights of any mortgagor, landlord, creditor or any other person whomsoever which existed prior to the date of death of the deceased person; and
  - (b) be subject to the requirement that the surviving spouse or child concerned shall occupy or use the property in question without detriment or neglect, reasonable wear and tear being excepted.
- (8) When the rights conferred by subsection (1) terminate or are waived by all of the entitled persons, the family home and household effects shall be distributed to the heirs and legatees in accordance with this Act.
- (9) If there is more than one surviving spouse, each surviving spouse shall be entitled under subsection (1) to the family home where they normally resided immediately prior to the death of the deceased, and the household effects associated with that family home.

## **DISQUALIFICATION AND WAIVER**

7. (1) Any beneficiary who is proved to have intentionally caused the death of the deceased is disqualified from inheriting any part of the property of the deceased.
  - (2) If
    - (i) a person is disqualified from being an heir of the estate of the deceased or
    - (ii) any person, excluding a minor or mentally ill person, renounces his or her right to be an heir of an estate or to receive a benefit from an estate to which he or she is entitled,

the estate of the deceased shall devolve as if such person had died immediately before the deceased, without leaving descendants: Provided that, any person entitled to a share in the estate of the deceased may waive his or her share in the estate in favour of a priority dependant.

### **FORCED LEVIRATE OR SORORATE MARRIAGE**

8. It shall be a criminal offence for any person to coerce the surviving spouse of a deceased person to enter a levirate or sororate marriage against that spouse's will, punishable upon conviction by a fine or imprisonment as determined by the Minister of Justice by notice in the Gazette, or both.

### **SHORT TITLE AND COMMENCEMENT**

9. This Act shall be called the Intestate Succession Act and shall come into operation on a date to be determined by the Minister of Justice by notice in the Gazette.

---

## Schedule

### LAWS REPEALED

No. and year of law	Title, subject or heading	Extent of repeal
The Political Ordinance of 1 April 1580 ("Groot Placaet-Boek", Part 1)	"Ordonnantie van die PolicienbinneHollandt"	Articles 19 to 29 inclusive
Interpretation of 13 May 1594 ("Groot Placaet-Boek", Part 1)	"Verklaring van de Heeren Staten van Hollandt en de Wes-Vrieslandt op de Ordonnantie van de Successien."	The whole
Octrooi op 10 January 1661 ("Groot Placaet-Boek", Part 2)	"Octrooi, by haerHoogMog: VerleentaendeOost-IndischeCompagniedeser Landen op 't recht van de Successienabintestatio in Oost-Indien, ende op de reysegintsendeherwaerts"	The whole
Proclamation 15 of 1928	Native Administration proclamation	Section 18
Ordinance 12 of 1946	Intestate Succession Ordinance 12 of 1946	The whole
Proclamation 36 of 1941	Administration of Estates (Rehoboth Gebiet) Proclamation, 1941	The whole
Act 15 of 2005	Estates and Succession Amendment Act	Section 1(2), 2(2) and 2(3)

**Explanatory Notes for Succession and Estates**

**INTESTATE SUCCESSION BILL**

**To regulate anew the law relating to intestate succession and to provide for matters connected therewith.**

**INTERPRETATION**

1. In this Act, unless the context otherwise requires -

“ascendants” mean the persons from whom the deceased person descended and include parents, grand-parents and great-grandparents;

"child" means a child born in, or out of marriage, including a marriage under Customary law, and an adopted child, and for the purposes of this Act, a child who is conceived but not yet born: Provided such child is subsequently born alive;

1. Provision has been made in the definition for children born out of the marriage and adopted children.

2. The definition includes the Common law principle namely the Nasciturus fiction. The law protects the potential interests of the nasciturus by employing the fiction that the fetus is regarded as having been born at the time of conception whenever it is to his/her advantage.

The Latin phrase “Nasciturus pro iam nato habetur, quotiens de commodo eius agitur” (“The unborn is deemed to have been born to the extent that its own benefits are concerned”) refers to law that allows a fetus to inherit if it is to benefit his/her. The requirements for the fiction are:

- ✓ An advantage/benefit that accrues to the fetus if he/she was alive
- ✓ The child must have been conceived
- ✓ Subsequent birth (the child must have been born alive)

“collaterals” mean blood relations who are not ancestors or descendants but who are related to each other through a common ancestor including but not limited to brother/sister, half brother/half sister, uncle/aunt, niece/nephew, cousins;

- "Court" means the High Court of Namibia or any judge thereof;
- "customary law" means the law, customs, norms, rules of procedure, traditions and practices observed among a traditional community in so far as they do not conflict with the provisions of the Namibian Constitution or any other statutory law applicable in Namibia;
- "deceased" means a person who dies after the commencement of this Act;
- "descendant" in relation to any person means the children and grandchildren of that person;
- "estate" means all property, movable and immovable, and claims and transferable rights which belong to a deceased person but excludes property which immediately before the death of a deceased was family or traditional property held in trust for the benefit of others in accordance with customary law and property which was institutionalised property of a traditional authority and had been acquired and was being held as part of the traditional authority's property;
- "intestate estate" includes any property of a deceased person which does not devolve by virtue of a valid will;
- "levirate marriage" means a marriage between a widow and the brother of the deceased;
- "household effects" shall include, without being limited to, any furniture, furnishings, appliances, utensils, agricultural implements, tools, consumable stores or other things which a surviving spouse or child of the deceased was normally using in relation to the normal family home where that spouse or child resided immediately before the death of the deceased, but excludes items used primarily for business purposes, money or securities;
- "priority dependant" means a spouse, child or parent of the deceased;
- "sororate marriage" means a marriage between a widower and the sister of the deceased;
- "spouse" means a person to whom the deceased was married at the time of his or her death including a person or persons to whom the deceased was married under customary law including a person in respect of whom

some customary marriage rites have been performed but were incomplete at the time of the deceased's death;

“will” means a will to which the provisions of the Wills Act, 1953 (Act No. 7 of 1953), apply.

## APPLICATION

2. (1) This Act shall apply to the estates of all persons who died after the commencement of this Act.
- (2) Only the deceased's share of any marital property shall form part of the estate of the deceased.
- (3) If the deceased was married or separated, the Master shall not authorize the distribution of the estate until satisfied that all relevant property has been divided according to the applicable marital property regime or any applicable agreement with respect to marital property.

## INTESTATE SUCCESSION

3. (1) If after the commencement of this Act a person (hereinafter referred to as the “deceased”) dies intestate, either wholly or in part, his or her estate shall be distributed among the heirs in the following manner, subject to section 5:
  - (a) If the deceased is survived by one or more than one spouse, but not by a descendant such spouse or spouses shall inherit the whole intestate estate of the deceased; Provided that where the deceased is survived by more than one spouse, who is entitled to inherit under this Act, such spouses shall share the estate in equal shares;

### Distribution Section 3(1)(a):

#### ***Example A:***

The deceased leaves a spouse to whom he/she was married **out** of community of property, but no children. Balance for distribution is N\$ 500 000:



**Solution:**

Surviving spouse will inherit the whole estate: N\$ 500 000

**Example B:**

The deceased leaves a spouse to whom he/she was married in community of property, but no children. Balance for distribution is N\$ 500 000:

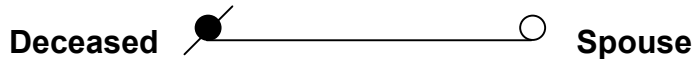

**Solution:**

Surviving spouse will receive half of the joint estate by virtue of the marriage in community of property: N\$ 250 000

Surviving spouse will inherit half of the remaining half of the joint estate in terms of the Intestate Succession Act: N\$ 250 000

**Example C:**

The deceased leaves two spouses to whom he was married in terms of the customary law, but no children. Balance for distribution is N\$ 500 000:

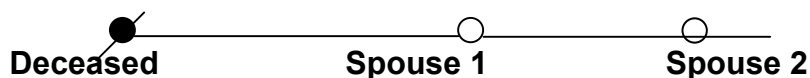

**Solution:**

Surviving spouses will inherit the estate in equal shares:

Spouse 1: N\$ 250 000

Spouse 2: N\$ 250 000

- (b) If the deceased is survived by descendants, but not by a spouse, such descendants shall inherit the whole intestate estate *per stirpes*;

**Distribution Section 3(1)(b):**

**Example A:**

The deceased leaves no spouse and is survived by two children. Balance for distribution is N\$ 500 000:

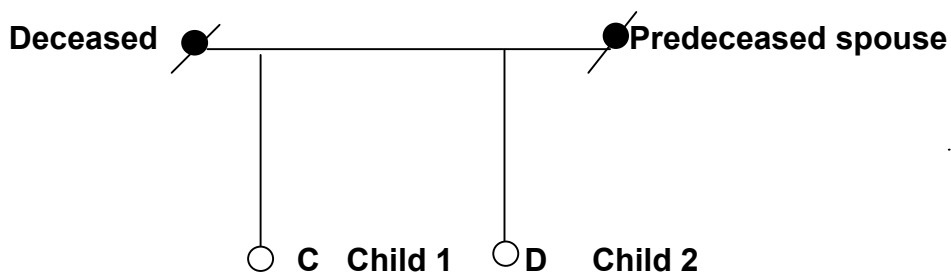

**Solution:**

Children will inherit the whole estate in equal shares:

C (Child 1) will inherit:	N\$ 250 000
D (Child 2) will inherit:	N\$ 250 000

**Example B:**

The deceased leaves no spouse, but is survived by one child and two grandchildren. Balance for distribution is N\$400 000.

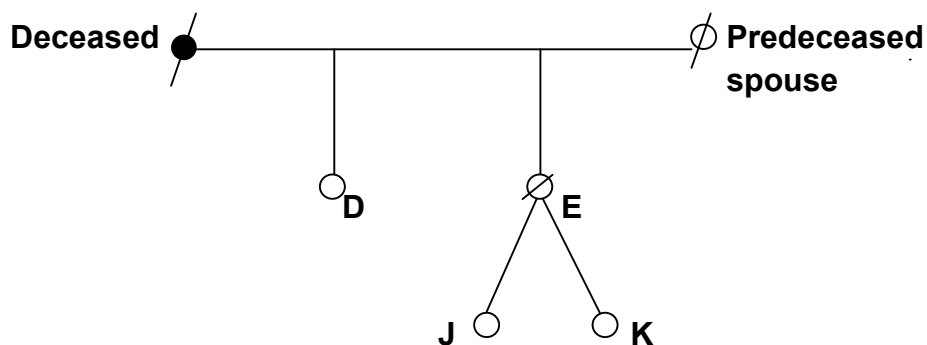

D = child of the deceased  
 E = predeceased child of the deceased  
 J & K = grandchildren of the deceased



**Solution:**

The deceased's children, D, & E will inherit the estate in equal shares (N\$200 000 each).

Because E is predeceased, his/her descendants, J and K will represent him/her. E's N\$200 000 will therefore be divided in equal shares between J & K, each receiving NS100 000.

- (c) If the deceased is survived by descendants and one spouse or more than one spouse, such spouse or spouses shall inherit one-half of the intestate estate of the deceased in equal shares or so much of the intestate estate of the deceased as does not exceed in value the amount fixed from time to time by the Minister of Justice by notice in the Gazette, whichever is the greater, and such descendants shall inherit the residue (if any) of the intestate estate of the deceased *per stirpes*.

**Distribution Section 3(1)(c):**

**Example A:**

Where the deceased leaves a spouse to whom he/she was married **out** of community of property and two children. Balance for distribution is N\$ 200 000:

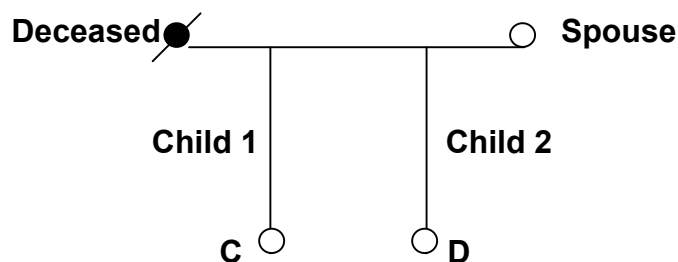

**Solution:**

Surviving spouse will inherit half of the estate:	N\$ 100 000
Children will inherit the other half in equal shares:	
Child 1 will inherit:	N\$ 50 000
Child 2 will inherit:	N\$ 50 000

**Example B:**

Where the deceased leaves a spouse to whom he/she was married **in** community of property and two children. Balance for distribution is N\$ 200 000:

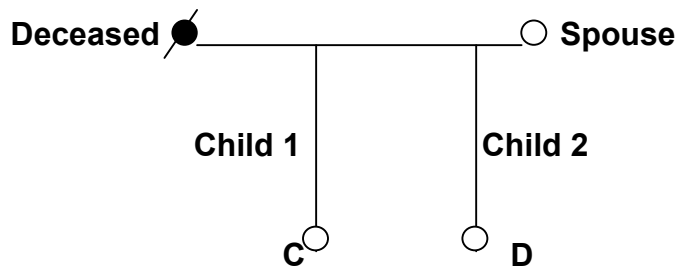

**Solution:**

Surviving spouse will receive half of the joint estate by virtue of the marriage	N\$ 100 000
Surviving spouse will inherit half of the remaining half of the joint estate:	N\$ 50 000
Children will inherit the other half in equal shares:	
Child 1 will inherit:	N\$ 25 000
Child 2 will inherit:	N\$ 25 000

**Example C:**

Where the deceased leaves a spouse to whom he/she was married **out** of community of property and two children. One of the children passed away before the deceased and left two children. Balance for distribution is N\$ 300 000:

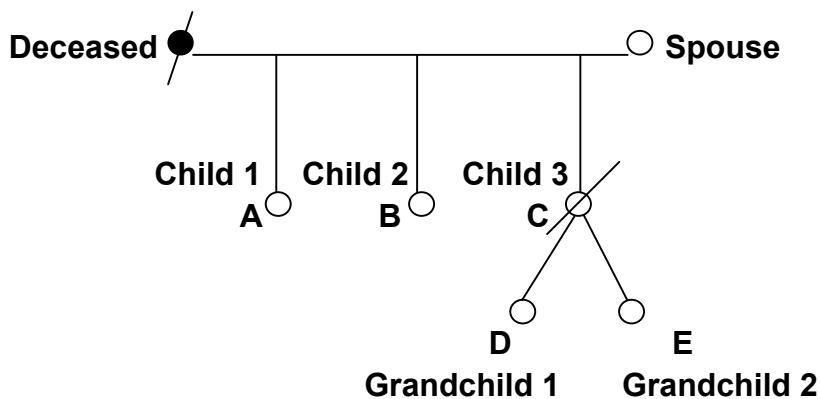

**Solution:**

Surviving spouse will inherit half of the estate:	N\$ 150 000
Children will inherit the other half in equal shares:	
A (Child 1) will inherit:	N\$ 50 000
B (Child 2) will inherit:	N\$ 50 000

D and E, the children (Grandchild 1 and 2) of C (Child 3) will each inherit 25 000 each. This represents the N\$ 50 000 that would have devolved upon C had he been alive as they now represent C.

(d) If the deceased is not survived by a spouse or descendant, but is survived:

- (i) by both his or her parents, his or her parents shall inherit the intestate estate in equal shares; or

**Distribution Section 3(1)(d)(i):**

**Example:**

The deceased leaves no spouse or descendants but leaves both parents who are still alive – the parents will inherit in equal shares. Balance for distribution is N\$ 60 000.

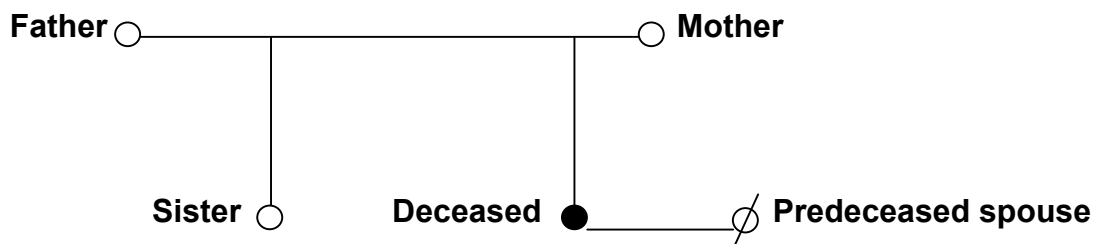

**Solution:**

Father will inherit:	N\$ 30 000
Mother will inherit:	N\$ 30 000

- (ii) by one of his or her parents, the surviving parent shall inherit half of the intestate estate and the descendants of the deceased parent who have survived the deceased shall inherit the other half *per stirpes*, or

**Distribution Section 3(1)(d)(ii):**

**Example:**

The deceased leaves no spouse and no descendants but leaves one parent, while the deceased parent left descendants– the surviving parent inherits one half, and the descendants of the deceased parent inherits the other half. Balance for distribution is N\$ 60 000.

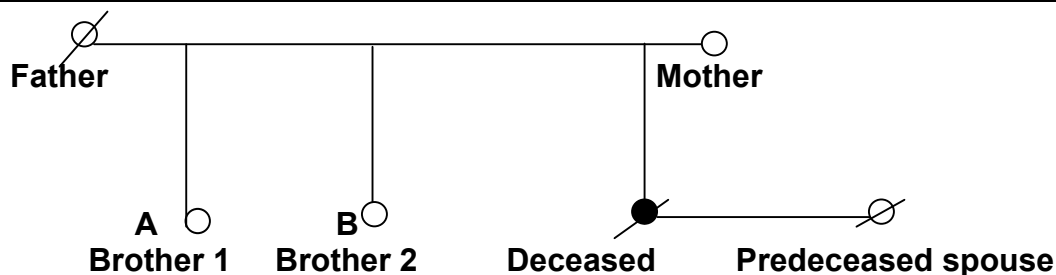

**Solution:**

Mother will inherit: N\$ 30 000

A and B will inherit the half of the predeceased father in equal shares:

A (Brother 1) will inherit: N\$ 15 000

B (Brother 2) will inherit: N\$ 15 000

- (e) if there are no such descendants who have survived the deceased, the surviving parent shall inherit the whole intestate estate.

**Distribution Section 3(1)(d)(iii):**

**Example:**

The deceased leaves no spouse or descendants but leaves one surviving parent, while the deceased parent did not leave any other descendants – the surviving parent is the sole heir. Balance for distribution is N\$ 60 000.

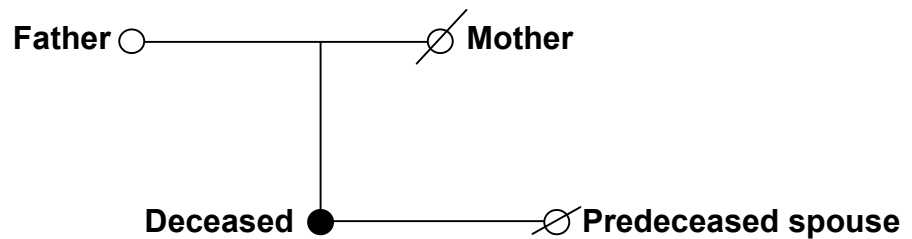

**Solution:**

Father will inherit: N\$ 60 000

- (f) If the deceased is not survived by a spouse or descendant or parent, but is survived by
- i. descendants of the deceased's parents, the surviving descendants related to the deceased through the deceased's mother shall inherit one half of the estate and the surviving descendants related to the deceased through the deceased's father shall inherit the other half of the estate; or

**Distribution Section 3(1)(e)(i):**

**Example:**

The deceased does not leave a spouse or descendants or parents, while his/her parents both have left descendants – the descendants of the predeceased parents will inherit the half shares that would have been inherited by the respective parents.  
Balance for distribution N\$ 60 000.

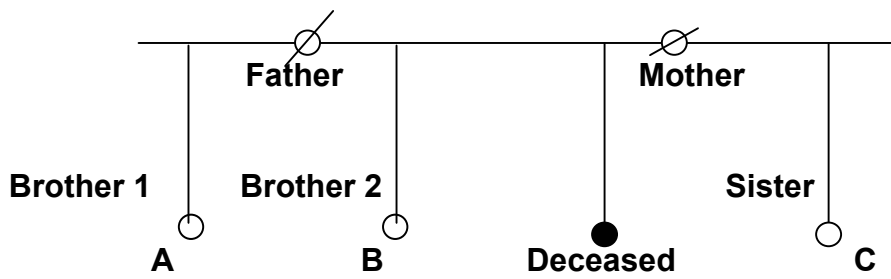

**Solution:**

A (Brother 1) will inherit on deceased father's side:	N\$ 15 000
B (Brother 2) will inherit on father and mother's side:	N\$ 30 000
C (Sister) will inherit on deceased mother's side:	N\$ 15 000

- ii. only descendants of one of the deceased parents of the deceased who are related to the deceased through such parent alone, such descendants shall inherit the intestate estate.

**Distribution Section 3(1)(e)(ii):**

**Example:**

The deceased does not leave a spouse, or descendants or parents, while only one of his/her predeceased parents has left descendants – the descendants of the parent who left descendants, are the sole heirs. Balance for distribution N\$ 60 000.

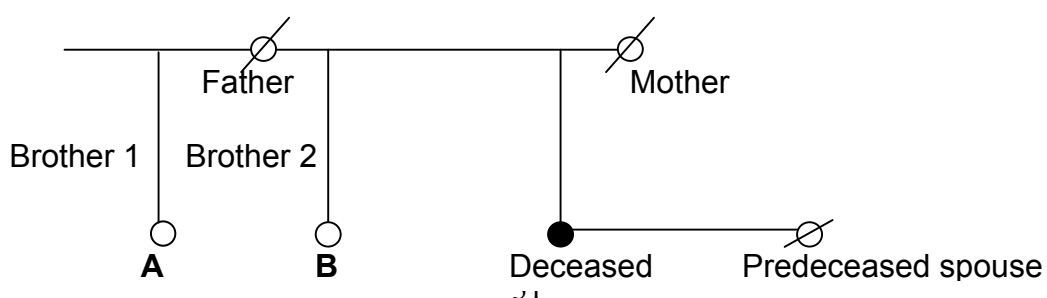

**Solution:**

A (Full blood brother of the deceased) will inherit:	N\$ 30 000 (from the Mother's side) N\$ 15 000 (from the Father's side)
B (Half blood brother of the deceased) will inherit:	N\$ 15 000 (from the Father's side)

(g) If the deceased is not survived by a spouse, descendant, parent or a descendant of a parent,

(i) the other blood relation or blood relations of the deceased who are related to him or her nearest in degree, shall inherit the estate in equal shares; or

**Distribution Section 3(1)(f)(i):**

The deceased is not survived by a spouse, descendant, parent or a descendant of a parent but only by an uncle, cousin and second cousin.

**Example:**

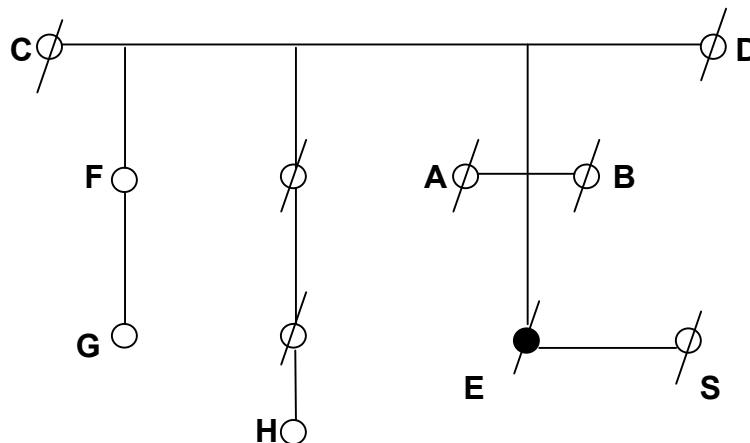

C, D = predeceased grandparents  
A, B = predeceased parents  
E = the deceased  
S = predeceased spouse  
F = uncle  
G = cousin  
H = second cousin

**Solution:**

F, the uncle of the deceased, is his/her nearest blood relation, being related to the deceased in the third degree, and will therefore inherit the whole balance for distribution.

G is related to E in the fourth degree and H is related to E in the fifth degree. Both G and H will not inherit anything from E.

- (ii) if there is no such blood relation, the intestate estate shall be paid into the Guardian's Fund as contemplated in Chapter V of the Administration of Estates Act 1965 (Act No. 65 of 1965).

Section 92 of the Administration of Estates Act 66 of 1965 provides that unclaimed monies that are paid into the Guardian Fund will be forfeited to the State after a period of 30 years and it is therefore not necessary to make provision for the scenario in subsection 3(g)(ii) where there are no relatives who can inherit from the deceased.

- (2) The degree of relationship between blood relations of the deceased and the deceased
  - (a) in the direct line, shall be equal to the number of generations between the ancestor and the deceased or the descendant and the deceased (as the case may be);
  - (b) in the collateral line, shall be equal to the number of generations between the blood relations and the nearest common ancestor, plus the number of generations between such ancestor and the deceased.

The degree of relationship between blood relations of the deceased and the deceased can be divided into two groups, namely the degree of relationship in the direct line and the degree of relationship in the collateral line.

In the **direct line**, the degree of relationship is equal to the number of generations between the ancestor and the deceased or the descendant and the deceased.

**Example:**

Parents and children of the deceased are both related to the deceased in the **first degree**.

Grandparents and grandchildren are related to the deceased in the **second degree**

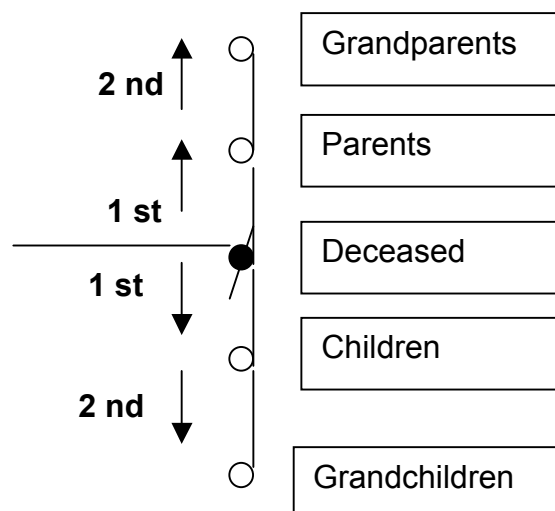

In the collateral line, the degree of relationship is equal to the number of generations

In the **collateral line**, the degree of relationship is equal to the number of generations between the blood relations and the nearest common ancestor, **plus** the number of generations between such ancestor and the deceased.

**Example:**

- C & D - predeceased grandparents
- A & B - predeceased parents
- E - the deceased
- S - predeceased spouse
- F & G - uncles/aunts
- H & I - cousins
- J - second cousin

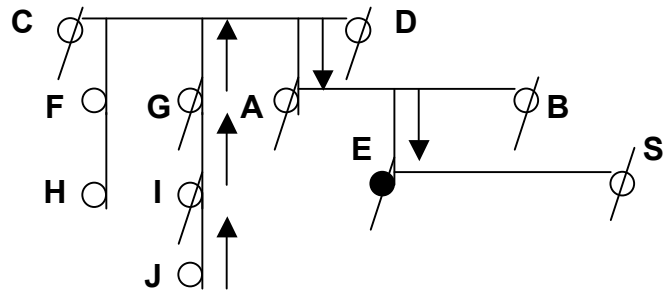

C & D, the predeceased grandparents, are the nearest common ancestors shared by both J and E (the deceased). F is thus related to the deceased in the third degree, H in the fourth degree and J in the fifth degree.

**4. ADOPTED CHILDREN**

- 4. An adopted child shall be deemed -
  - (a) to be a descendant of his or her adoptive parent or parents;
  - (b) not to be a descendant of his or her natural parent or parents or any previous adoptive parent or parents, except in the case of a natural parent who is also the adoptive parent of the child concerned or a natural guardian who was married to the adoptive parent of the child concerned at the time of the adoption.

**CUSTOMARY LAW**

- 5. (1) An intestate estate will be distributed as contemplated in section 3 of this Act unless a certificate is issued by a Community Court and lodged with the Master stating that the deceased was either living at the time of his or her death in accordance with or closely connected to customary law, in which case the estate of the deceased will be distributed in accordance with this section.
- (2) The intestate estate of the deceased will devolve as follows:
  - (a) eighty percent shall be distributed to the beneficiaries under section 3 of this Act and;
  - (b) twenty percent shall be distributed amongst customary law heirs who are not included in section 3 of this Act.



- (3)
  - (a) Where this section is applicable, the executor of the estate shall draw up an inheritance plan providing for the distribution of the portion of the estate which falls under this section in terms of the applicable customary law, after consulting in so far as practical, with the deceased person's family and the beneficiaries.
  - (b) The executor shall submit the inheritance plan in the prescribed form to the Master for approval together with the liquidation and distribution account.
  - (c) Should it not prove possible to secure the agreement of the majority of the beneficiaries to the inheritance plan, the executor shall consult an appropriate Traditional authority for guidance in ascertaining the applicable customary law.
  - (d) The Traditional authority must provide such guidance in writing to the executor within thirty days from receipt of a request as provided for in subsection 5(3)(c).

## **FAMILY HOME**

6.
  - (1) Notwithstanding the above and any valid will of the deceased, but subject to subsection (4) below, should the surviving spouse so desire and is not be financially able to afford to either rent or purchase a comparable residential property and is not be the owner of residential property, the surviving spouse shall have a right of *usus* over the property owned by the deceased in which they normally resided as at date of death, together with the furniture therein, until his or her death or remarriage whichever is the sooner: Provided that such right of *usus* does not have preference over the rights of creditors against the estate.
  - (2) "Family home" shall include any property held by the deceased prior to death in terms of the Communal Land Reform Act 2002(Act No. 5 of 2002) or any prior legislation , and in the event of any conflict, the provisions of this Act shall prevail.
  - (3) The right of *usus* must be registered against the property, other than property referred to under subsection (2), with the Registrar of Deeds by the executor or estate representative and proof thereof must be lodged with the Master.
  - (4) Subsection (1) is subject to the surviving spouse assuming responsibility for payment of the rates and taxes, any other municipal services, any levies in respect of such property, insurance and the maintenance of the property.

- (5) The executor, estate representative or any interested person may apply to the Master to cancel the right of *usus* upon non-compliance with subsection (4).
- (6) The Master shall upon cancellation of the *usus* over immovable property instruct the Registrar of Deeds to cancel the right of *usus* registered against such property.
- (7) The rights conferred by subsection (1) shall—
  - (a) not derogate from or prejudice in any way the rights of any mortgagor, landlord, creditor or any other person whomsoever which existed prior to the date of death of the deceased person; and
  - (b) be subject to the requirement that the surviving spouse or child concerned shall occupy or use the property in question without detriment or neglect, reasonable wear and tear being excepted.
- (8) When the rights conferred by subsection (1) terminate or are waived by all of the entitled persons, the family home and household effects shall be distributed to the heirs and legatees in accordance with this Act.
- (9) If there is more than one surviving spouse, each surviving spouse shall be entitled under subsection (1) to the family home where they normally resided immediately prior to the death of the deceased, and the household effects associated with that family home.

This section attempts to protect the surviving spouse and his or her children from being evicted from the family home after the death of the deceased. A right of *usus* gives the spouse a right to reside in the property.

#### 1. Definition of *usus*

It entitles a person to use another's property, but not to appropriate the fruits of the property. The usuary never becomes the owner of the property he uses. A value is given to this right of use and a distinction is then made between the value of the right to use and the value of the property rights over the thing.

The right of use can be acquired over land, a house or animals, and in each of these the usuary may use the thing without becoming the owner of the fruits of the thing or the thing itself.

## **DISQUALIFICATION AND WAIVER**

7. (1) Any beneficiary who is proved to have intentionally caused the death of the deceased is disqualified from inheriting any part of the property of the deceased.

(2) If

(i) a person is disqualified from being an heir of the estate of the deceased or

(ii) any person, excluding a minor or mentally ill person, renounces his or her right to be an heir of an estate or to receive a benefit from an estate to which he or she is entitled,

the estate of the deceased shall devolve as if such person had died immediately before the deceased, without leaving descendants: Provided that, any person entitled to a share in the estate of the deceased may waive his or her share in the estate in favour of a priority dependant.

Major children sometimes wish to renounce their inheritance in favor of a parent (surviving spouse). Such share currently falls into the residue of the estate and is distributed amongst the remaining intestates succession heirs which is not what the renouncing heir intended.

## **FORCED LEVIRATE OR SORORATE MARRIAGE**

8. It shall be a criminal offence for any person to coerce the surviving spouse of a deceased person to enter a levirate or sororate marriage against that spouse's will, punishable upon conviction by a fine or imprisonment as determined by the Minister of Justice by notice in the Gazette, or both.

## **SHORT TITLE AND COMMENCEMENT**

9. This Act shall be called the Intestate Succession Act and shall come into operation on a date to be determined by the Minister of Justice by notice in the Gazette.

## Schedule

### LAWS REPEALED

No. and year of law	Title, subject or heading	Extent of repeal
The Political Ordinance of 1 April 1580 ("Groot Placaet-Boek", Part 1)	"Ordonnantie van die Policienbinne Hollandt"	Articles 19 to 29 inclusive
Interpretation of 13 May 1594 ("Groot Placaet-Boek", Part 1)	"Verklaring van de Heeren Staten van Hollandt en de Wes-Vrieslandt op de Ordonnantie van de Successien."	The whole
Octrooi op 10 January 1661 ("Groot Placaet-Boek", Part 2)	"Octrooi, by haerHoogMog: VerleentaendeOost-IndischeCompagniedeser Landen op 't recht van de Successienabintestatio in Oost-Indien, ende op de reysegintsendeherwaerts"	The whole
Proclamation 15 of 1928	Native Administration proclamation	Section 18
Ordinance 12 of 1946	Intestate Succession Ordinance 12 of 1946	The whole
Proclamation 36 of 1941	Administration of Estates (Rehoboth Gebiet) Proclamation, 1941	The whole
Act 15 of 2005	Estates and Succession Amendment Act	Section 1(2), 2(2) and 2(3)

**DRAFT ADMINISTRATION OF ESTATES AMENDMENT BILL**

**EXPLANATORY NOTE:**

\_\_\_\_\_ Words underlined with solid line indicate insertions in existing enactments.

[                    ] Words in bold type in square brackets indicate omissions from existing enactments.

---

**BILL**

**To amend the Administration of Estates Act, 1965 to provide for the protection of surviving spouses and children and their maintenance in certain respects.**

*(Introduced by the Minister of Justice)*

**BE IT ENACTED** by the Parliament of the Republic of Namibia as follows:-

**Insertion of sections 26A and 80A in Act No. 66 of 1965**

1. The following section is inserted after section 26 of the Administration of Estates Act, 1965 (Act No. 66 of 1965):

**“PROPERTY-GRABBING**

26A. (1) Notwithstanding any law, including customary law, to the contrary, and regardless of whether the estate is testate or intestate, when any person dies, any surviving spouse or child of such person shall have the following interim rights until such time as the administration and distribution of the estate is finalized or the immovable property is sold by the executor or estate representative with the consent of the Master during the administration of the estate —

(a) the right to occupy any immovable property which the deceased had the right to occupy and which such surviving spouse or child was ordinarily occupying immediately before the death of the deceased;

(b) the right to use any household effects which immediately before the death of the deceased were associated with that property;

(c) the right to use, but not slaughter, any animals which immediately before the death of the deceased were pastured or kept on such immovable property;

(d) to an extent that is reasonable for the support of such surviving spouse or child, the right to any crops which immediately before the death of the deceased were growing or being produced on such immovable property.

(2) Any person who-

(a) acts with the intention of depriving any other person of any right under subsection (1), or interferes in any way with such right;

(b) removes, destroys, alienates or otherwise unlawfully interferes with the property of the deceased person before the administration and distribution of the estate is finalized; or

(c) removes any child of the deceased from the care and control of the surviving parent without proper state authority;

shall be guilty of an offence and liable to a fine or to imprisonment for a period determined by Minister of Justice of in Government Gazette or to both such fine and such imprisonment.

(3) A court convicting a person of an offence in terms of subsection (2) may order the convicted person or any other person to restore any property or the monetary value of such property, or to pay any money which he has unlawfully acquired, to the person entitled thereto in terms of subsection (1), or to any other person specified

by the court, and any such order shall have the same effect and may be executed in the same manner as if the order had been made in a civil action instituted in the court.

- (4) The rights conferred by subsection (1) shall—
- (a) not derogate from or prejudice in any way the rights of any mortgagor, landlord, creditor or any other person whomsoever which existed prior to the date of death of the deceased person; and
  - (b) be subject to the requirement that the surviving spouse or child concerned shall occupy or use the property in question without detriment or neglect, reasonable wear and tear being excepted.”

2. The following section is inserted after section 80 of the Administration of Estates Act, 1965 (Act No. 66 of 1965):

**“Maintenance of Dependents**

80A. (1) For the purposes of this section, “dependant”, in relation to a deceased, means—

- (a) a surviving spouse;
- (b) a divorced spouse who at the time of the deceased’s death was entitled to the payment of maintenance by the deceased in terms of an order of court;
- (c) a partner in a long-term life partnership in the nature of a marriage who was being maintained by the deceased at the time of death;
- (d) a person who was treated as a spouse or a child of the deceased as the result of a levirate or sororate union;
- (e) a minor child;

- (f) a major child who is, by reason of some mental or physical disability, incapable of maintaining him or her self and who was being maintained by the deceased at the time of death;
  - (g) a parent who was being maintained by the deceased at the time of death; and
  - (h) any other person in respect of whom the deceased at the time of death-
    - (i) was making a substantial contribution in money or in kind towards the maintenance of that person the deceased at the time of his death; or
    - (ii) was obligated to pay maintenance.
- (2) No estate may be distributed until the maintenance needs of all dependents have been satisfied in accordance with this section: Provided that nothing in this subsection shall be construed as preventing the executor, before the application is finally determined, from disbursing any part of the estate for the purpose of providing maintenance for any person who was totally or partially dependent on the deceased immediately before his death.
- (3) Any dependant of a person who dies after the commencement of this Act may make application in the prescribed form for an award of maintenance from the testate or intestate estate of the deceased, provided that such application is lodged with the Master within three months of the date of the grant of letters of administration to the executor of the deceased estate concerned, unless the Master has, on good cause shown, granted an extension of the period within which the application shall be made.
- (4) On receipt of an application under subsection (3), the Master, shall —



- (a) make such initial investigation in connection with the application as he or she considers necessary;
  - (b) direct the executor to take such measures within such period as the Master may specify and may direct the executor to submit such report or statement to him as the Master may specify; and
  - (c) take such steps as he or she considers necessary and practicable in the circumstances to obtain the view of the heirs and legatees, and invite the heirs or legatees of the deceased to make such representations as they may wish in connection with the application.
- (5) An applicant who is himself the executor of the estate of the deceased concerned and who wishes to make an application shall not be precluded therefrom but, in such event, the Master may approach the appropriate court for the appointment of a curator ad litem to represent the estate in connection with the application and the expenses incurred in connection with such appointment shall be defrayed out of the estate.
- (6) The Master shall, after considering the information collected and provided in terms of subsections (4) refer the application together with such information to the appropriate court for a decision on the application for maintenance.
- (7) The clerk of court shall cause notice to be given in the prescribed manner to all heirs and legatees of the court hearing.
- (8) Before making a decision on an application submitted in terms of subsection (6), the court shall give due regard to-
- (a) whether or not the dependant is in need of maintenance, taking into account, where the deceased died leaving a will, the benefits, if any, to which the dependant will be entitled under the will or, where the deceased died intestate, the benefits, if any, to which the dependant will be entitled on intestacy;

- (b) the period for which maintenance of the dependant is required;
- (c) the ability of the dependant to maintain himself or herself, in light of the applicant's earning capacity and his or her financial obligations and responsibilities;
- (d) the responsibilities and needs which each of the dependents of the deceased has and is likely to have in the foreseeable future;
- (e) the number of persons to be maintained by the estate;
- (f) the general standard of living of the dependant and, during his lifetime, of the deceased;
- (g) where the deceased died leaving a will, the interests of the beneficiaries in respect of whom provision has been made under the will, or, where the deceased died intestate, the interests of the persons who would succeed on intestacy;
- (h) the size and nature of the deceased's estate;
- (i) any other matter which, in the opinion of the appropriate court, is relevant to the determination of the issue;
- (j) where the applicant is a surviving spouse or cohabiting partner of the deceased-
  - (i) the age of the applicant;
  - (ii) the nature and duration of the marriage or relationship;
  - (iii) the contribution made by the applicant to the welfare of the family of the deceased, including any contribution made by looking after the home or caring for the family; and

- (i) in the case of a surviving spouse, the provision which the applicant might reasonably have expected to receive if, on the day on which the deceased died, the marriage, instead of being terminated by death, had been terminated by a decree of divorce; and
- (k) where an application is made by a child of the deceased,
  - (i) the age of the child;
  - (ii) the financial, educational and developmental needs of the child, including but not limited to housing, water, electricity, food, clothing, transport, toiletries, child care services, education (including pre-school and tertiary education) and medical services;
  - (iii) the manner in which the dependent is being, and in which his or her parents reasonably expect him or her to be, educated or trained;
  - (iv) any special needs of the dependent, including but not limited to needs arising from a disability or other special condition; and
  - (v) the maintenance which is or can be reasonably provided by the child's surviving parent or guardian.
- (9) An award of maintenance made in terms of this section may take the form of
  - (a) periodical payments to the applicant out of the estate of the deceased in such amounts and for such definite or indefinite period as may be specified;
  - (b) payment to the applicant of a lump sum out of the estate of the deceased in such amount as may be specified; or

- (c) payment from the estate of the deceased into the Guardian's Fund referred to in section 86 of the Administration of Estates Act, 1965 (Act No. 66 of 1965), of money for the credit of any person, to be distributed in periodic payments or as a lump sum or otherwise, as directed;

and in the case of any periodic payments in terms of (a) and (c) the court may direct that a portion of the estate shall be set aside to be sufficient, at the date of the award, to produce by the income thereof the amount for the making of those payments.

- (10) (a) Any award in favour of an applicant who was the former spouse of the deceased shall, in so far as it provides for the making of periodical payments, cease to have effect on the remarriage of the applicant, except in relation to arrears due under the award on the date of the remarriage.

- (b) Any award in favour of an applicant who was the former cohabiting partner of the deceased shall, in so far as it provides for the making of periodical payments, cease to have effect on the marriage of the applicant, except in relation to arrears due under the award on the date of the marriage.

- (11) Where on application it appears to the court -

- (a) that the applicant is in urgent need of immediate financial assistance; and

- (b) that property forming part of the estate of the deceased is or can be made available to meet the needs of the applicant;

the court may direct that, subject to such conditions as it may impose and to any further order of the court, there shall be paid to the applicant out of the estate of the deceased such sum or sums at such intervals as the court directs until such date as is specified.

(12) Any person interested in the estate of the deceased concerned may apply in such form, if any, as may be prescribed, to the appropriate court for any award to be varied, suspended or rescinded on the grounds that—

(a) any material fact was not disclosed when the determination of the application for the award was made; or

(b) a substantial change has taken place in the circumstances of the dependant in whose favour the award was made

and if the appropriate court is satisfied as to the matters specified in paragraph (a) or (b), as the case may be, and that it is just in the circumstances to do so, it may vary, suspend or rescind any award or give such other direction in the matter as it deems fit: Provided that any such variation, suspension, rescission or direction shall apply only in respect of property to which the award was applicable.

(13) The Minister may make regulations in terms of this subsection, which are in the Minister's opinion, convenient or necessary for carrying out or giving effect to the purposes of this section.

(14) The provisions of this Act shall not be construed as derogating from the rights of any person to maintenance out of a deceased estate, which he has in terms of any other law.

(15) This section shall apply to all estates regardless of whether such estates are testate or intestate.”

3. This Act shall be called the Administration of Estates Amendment Act, 2012.

***Berendt and Another v Stuurman and Others 2003 NR 81 HC***

BERENDT AND ANOTHER v STUURMAN AND OTHERS

HIGH COURT

MANYARARA AJ

2003 May 16, July 14

Administration of estates--Intestate succession--Native Administration Proclamation 15 of 1928--

Section 18 providing that estates of 'natives' should be administered by magistrate--Master not having power to administer such estate--Section constituting violation of Namibian Constitution because discriminating against certain groups--Section declared unconstitutional--Parliament ordered to remedy defect.

The deceased, a member of the B community died intestate. Second respondent was appointed as executor of the estate which was to be administered in terms of s 18 of the Native Administration Proclamation 15 of 1928. Second respondent had sold the house in which he and the two applicants had lived with the deceased, to the first respondent for a price allegedly way below market value.

In the present application the applicants sought to have s 18(1), 18(2) and 18(9) of the Proclamation declared unconstitutional, on the grounds that they were discriminatory. The proclamation applies only to the estates of so-called 'natives'. They sought an order to have 2nd respondent's appointment as executor set aside, as well as to set aside the agreement of sale.

The Court held, following the dictum in Moseneke and Others v The Master and Another 2001 (2) SA 18 (CC) at para [22] namely: 'There can be no doubt that the section and the regulation both

impose differentiation on the grounds of race, ethnic origin and colour, and as such constitute discrimination which is presumptively unfair in terms of s 9(5) of the Bill of Rights. The Minister and the Master suggested that the administration of deceased estates by magistrates was often convenient and inexpensive. However, even if there are practical advantages for many people in the system, it is rooted in racial discrimination, which severely assails the dignity of those concerned and undermines attempts to establish a fair and equitable system of public administration. Any benefits need not be linked to this form of racial discrimination but could be made equally available to all people of limited means or to all those who live far from the urban centres where the offices of the Master are located. Given our history of racial discrimination, I find that the indignity occasioned by treating people differently as "blacks", as both s 23(7) and the regulations do, is not rendered fair by the factors identified by the Minister and the Master. I conclude therefore that both provisions create unfair discrimination within the meaning of s 9(3) of the Constitution.

They also constitute a limitation of the right to dignity entrenched in s 10.'

The Court held that this case was on all fours with the present case and that it should be followed.

The Court set aside the appointment of the 2nd respondent as executor and ordered that the Master administer the estate in terms of the Administration of Estates Act 66 of 1965.

The Court also ordered that the agreement of the sale of the house be set aside; first respondent had the usual remedies of a bona fide purchaser.

The application was accordingly granted and Parliament was ordered to remedy the defect by 30 June 2005.

Application to declare certain sections of the Native Administration Proclamation 15 of 1928 unconstitutional and ancillary relief. The facts appear from the reasons for judgment.

G Narib for applicants.

G Coleman for 1st respondent.

No appearance for 2nd and 5th respondent.

N Marcus for 3rd, 4th, 6th and 7th respondents.

Cur advvult.

Postea (July 14.)

MANYARARA AJ: Martha Berendt (hereinafter referred to as the deceased) died unmarried and intestate on 20 March 1999. She was survived by three children, namely, the two applicants and the second respondent.

At the time of her death the deceased owned certain immovable property in Windhoek (the house) where she resided with the applicants and the second respondent. Following the deceased's death, the applicants and the second respondent as the heirs to the estate approached a member of their extended family for advice on the distribution of the estate.

The deceased was of the tribal community called the Bondelswart. Acting upon the advice received, the heirs visited the magistrate's court and agreed to the appointment of the second respondent as executor of the estate. It followed that the estate would be administered and distributed according to the customary law of the Bondelswart community in terms of the provisions of the Native Administration Proclamation 15 of 1928.

The second respondent, acting in his capacity as executor, entered into a deed of sale of the house to first respondent for a price of N\$20 000. After payment of debts owed by the estate, an amount of N\$5000 was paid into the estate to be shared among the heirs.

The applicants were dissatisfied with the turn of events. They sought and obtained legal advice on which they have approached this Court on notice of motion for relief. The founding affidavit sworn by



first applicant and supported by second applicant avers that second respondent sold the house behind their backs for a price well below market value and has also failed to account for the money he received. The applicants call in question the second respondent's appointment as executor and the consequences thereof. In the result, they seek an order, the main terms of which are these:

1. Declaring s 18(1) and 18(2) of the Native Administration Proclamation 15 of 1928 as well as the regulations made under s 18(9) thereof to be unconstitutional and invalid as being in conflict with the provisions of the Namibian Constitution;
2. Setting aside the appointment of second respondent as executor in the deceased's estate as unlawful, null and void;
3. Setting aside the deed of sale entered into between second and first respondent as null and void;
4. Declaring that the Administration of Estates Act 66 of 1965 shall apply to the deceased's estate;  
and
5. Directing fourth respondent to supervise the administration of the said estate in terms of the Administration of Estates Act 66 of 1965.

A costs order is sought against the first respondent 'and any other respondent opposing the application.'

At the hearing, Mr Narib appeared for the applicants, Mr Coleman for the first respondent and Mr Marcus for the third, fourth, sixth and seventh respondents. The second and fifth respondents will abide the decision of the Court.

1. The Constitutional Issue

The applicants contend that ss 18(1), 18(2) and 18(9) of the Native Administration Proclamation 15 of 1928 (the Proclamation) should be set aside as discriminatory, racist and outdated because the provisions subject the estates of black persons (defined by the Proclamation as 'natives') to a legislative regime which discriminates against them on the ground of race. The attack is founded on art 10 of the Constitution, which has

been interpreted by Strydom CJ in ;ansaMuller v President of the Republic of Namibia and Another 1999 NR 190 (SC) [appr] at 199 (2000 (6) BCLR 655 (Nms)) at 664H as follows:

'The grounds mentioned in art 10(2) namely sex, race, colour, ethnic origin, religion, creed or social or economic status, are all grounds which, historically, were singled out for discriminatory practices exclusively based on stereotypical application for presumed group or personal characteristics. Once it is determined that a differentiation amounts to discrimination based on one of these grounds, a finding of unconstitutionality must follow.'

The judgment continues at 200 (NR) 665F-G (BCLR) as follows:

'It seems to me that inherent in the meaning of the word discriminate is an element of unjust or unfair treatment. In South Africa, the Constitution clearly states so by targeting unfair discrimination, and thus makes it clear that it is that particular type of discrimination that may lead to unconstitutionality. Although the Namibian Constitution does not refer to unfair discrimination, I have no doubt that in the context of our Constitution that is also the meaning that should be given to it.'

The Proclamation applied to Namibia. Its South African equivalent was the Black Administration Act 38 of 1927. Section 23(7)(a) reg 3(1) thereof were challenged in Moseneke and Others v The Master and Another 2001 (2) SA 18 (CC) [appr] and appl]. SACHS J, with the concurrence of all the learned

Judges hearing the matter, struck down the impugned legislation at 30, para [22] on the following basis:

'There can be no doubt that the section and the regulation both impose differentiation on the grounds of race, ethnic origin and colour, and as such constitute discrimination which is presumptively unfair in terms of s 9(5) of the Bill of Rights. The Minister and the Master suggested that the administration of deceased estates by magistrates was often convenient and inexpensive. However, even if there are practical advantages for many people in the system, it is rooted in racial discrimination, which severely assails the dignity of those concerned and undermines attempts to establish a fair and equitable system of public administration. Any benefits need not be linked to this form of racial discrimination but could be made equally available to all people of limited means or to all those who live far from the urban centres where the offices of the Master are located.

Given our history of racial discrimination, I find that the indignity occasioned by treating people differently as "blacks", as both s 23(7) and the regulations do, is not rendered fair by the factors identified by the Minister and the Master. I conclude therefore that both provisions create unfair discrimination within the meaning of s 9(3) of the Constitution. They also constitute a limitation of the right to dignity entrenched in s 10.'

The deputy permanent secretary in the Ministry of Justice, Mr Issaskar Ndjodze, suggested in the answering affidavit he filed that the fact that the Proclamation and regulations made under it 'apply exclusively to natives in Namibia' does not render the provisions discriminatory. His reason, briefly stated, is that art 66 of the Namibian Constitution recognizes a dual legal system of common law and customary law.

Mr Ndjodze has obviously misunderstood the purpose of this application. Article 66 validates both common law and customary law in force in Namibia at independence, but only to the extent that such

common law or customary law does not conflict with the Constitution. See also art 140(1), which provides expressly that

'...all laws which were in force before the date of independence shall remain in force until repealed or amended by Act of Parliament or until they are declared unconstitutional by a competent Court.'

The present application does not seek to have customary law as such declared invalid; it seeks to have certain provisions of the Proclamation declared unconstitutional, in that the provisions discriminate against black persons on the enumerated grounds.

Mr Marcus concedes the point but argues that the applicants do not have locus standi to bring this application because they are not 'aggrieved persons' within the meaning of art 25(2) of the Constitution.

There is no substance in the submission. Locus standi means 'the right to be heard' and, in my view, the expression 'aggrieved persons' within the context of art 25(2) has a corresponding meaning. In casu the applicants are the heirs to the deceased's estate and, as such, they clearly have a right to institute proceedings and to be heard in any matter relating to the estate. Contrary to Mr Marcus' belief, it is also irrelevant to the point raised whether the administration and distribution of the estate in terms of the Administration of Estates Act may turn out to be less beneficial to the applicants than application of customary law.

2. Legal validity of the appointment of second respondent as executor of the estate and the deed of sale of deceased's house to first respondent

These two matters must be considered together for reasons which will emerge in due course.

It is common cause that a magistrate appointed second respondent as executor by agreement of the parties. Following his appointment and purporting to act in his capacity as executor, the second respondent entered into a deed of sale agreement with first respondent by which he sold the deceased's house to the first respondent for a purchase price of N\$20 000.

The applicants challenge the legality of second respondent's appointment as executor. They also contend that they were not consulted on the sale of the house or agreed thereto. In any event, so the contention continues, N\$20 000 is not a fair and reasonable price for the house.

First respondent resists the relief sought on the basis that he acquired ownership of the house by purchase from second respondent as the duly appointed executor of the deceased's estate. According to first respondent, his rights are those of a bona fide purchaser and such rights cannot be affected by the constitutionality of the legislation under which the transaction took place. In assertion of the alleged right, first respondent has filed a counter application to evict the applicants from the house and also claimed payment of N\$1200 per month from 12 August 2002 as damages for 'unlawful occupation of the property' by the applicants.

Regulation 3 of the regulations made under s 18(9) of the Proclamation provides as follows:

'All the property in any estate falling within the purview of para (a) of reg 2 shall be administered under the supervision of the Native Commissioner of the district or area in which the deceased ordinarily resided and such Native Commissioner shall give such directions in regard to the distribution thereof as shall deem to him fit and shall take all steps necessary to ensure that the provisions of the Proclamation and of these regulations are complied with.'

Regulation 2(a) relates to the estates of so-called natives devolving as if the deceased were a 'European.' It is apparent that it is by necessary implication that magistrates have exercised the power to appoint executors to such estates. There is also no provision that deals with the powers of magistrates to administer the estates of black persons, which are to devolve in terms of customary law. It is again by necessary implication that magistrates have assumed the power to administer such estates and to appoint executors therein.

It is on the above basis that Mr Ndjodze has sought to have all appointments made in exercise of the powers described upheld on the ground that the practice has existed without question since 1954 when the regulation came into operation.

Mr Coleman has pointed out that the practice is traceable to the omission by the Administrator of the then South West Africa (Namibia) to provide a similar legislative scheme for Namibia as existed under South Africa's Regulations for the Administration and Distribution of the Estates of Deceased Bantu (GN R34 of January 1966) Reg 4(1). That regulation made it unnecessary for the Bantu Affairs Commissioner in South Africa (the equivalent of native commissioner in Namibia) to issue 'letters of administration' or appoint an executor in the estates to which it applied. The regulation conferred a discretion on the Bantu Affairs Commissioner in whose area of jurisdiction the deceased Bantu (black person) ordinarily resided to issue a certificate 'to any person whom he may deem to be suitable, appointing him to represent the estate and to assume responsibility for the payment of debts, the collection of assets and the general administration and distribution of property.'

In this regard, Mr Ndjodze correctly avers that magistrates in Namibia have followed the practice of issuing letters of administration in the estates of black persons dying intestate as a practical measure of giving effect to the wishes and decisions of the deceased's family.'

Mr Ndjodze's contention is based on the principle that, subject to certain exceptions, the general rule is that 'invalidation of a statute existing at the date of commencement of the Constitution should not ordinarily have any retrospective effect, so as to avoid the dislocation and inconvenience of undoing transactions, decisions or actions taken under the statute.' ;ansa S v Zuma and Others 1995 (2) SA 642 (CC) [appr] at 663F.

Two hurdles stand in the way of Mr Ndjodze's contention and both are insurmountable.

The first such hurdle is the established principle of law that any action not covered by statutory authority is ultra vires and a nullity. The practice adopted by magistrates in Namibia is caught. See ;ansa Skeleton Coast Safaris v Namibia Tender Board and Others 1993 NR 288 (Hc) [ref] and ;anen Ministry of Agriculture and Fisheries v Matthews [1949] 2 All ER 724 (KB) [ref].

However, in my view, it is the second hurdle which effectively disposes of Mr Ndjodze's contention. This is that the Zuma judgment read as a whole is also authority for the proposition that the general rule against retroactivity is subject to the exception that there may be cases to which the general rule does not apply. In my view, the present case is such a case. I take this view for the reason that the price of N\$20 000, which the first respondent purportedly paid for the house, is suspicious as against the rental of N\$1200 a month claimed by first respondent. On such a rental, first respondent would recoup all the money he paid for the house in just over one year, which is scandalous. Consequently, it is in the interests of justice to restore the status quo ante.

It follows that the appointment of second respondent as executor and the agreement of sale he concluded with first respondent qua executor must be set aside, leaving first respondent to institute action against the estate to recover the money he has paid for the house. It also follows that consideration of Mr Coleman's submission that first respondent's rights as a bona fide purchaser should not be affected by invalidation of the impugned provisions of the Proclamation falls away.

3. Supervision of the estate by fourth respondent and application of the Administration of Estates Act, 1965 to the estate

Section 18(6) of the Proclamation prohibited the Master of the High Court from administering the estates of so-called natives. With the repeal of the provision by s 7 of Act 27 of 1985, there is nothing to prevent fourth respondent from supervising the estate of the deceased in this and similar instances or application of the Administration of Estates Act thereto. However, s 4 limits the jurisdiction of the Master to the estate of 'a person who was at his or her death ordinarily resident within the area of jurisdiction of a provincial division of the (High Court), with the Master appointed in respect of that area.' It is the wish of the applicants that the deceased's estate should be administered in terms of the Administration of Estates Act. Section 4 does not apply and, in the interest of curtailing litigation, their wish will be granted.

### Conclusion

This matter is on all fours with Moseneke supra and the result will be the same. In anticipation of the outcome, Mr Ndjodze requested that any order invalidating the impugned provisions of the Proclamation should be suspended for a period of three years.

The request is proper.

The purpose of the suspension of the Court's order is to give Parliament a reasonable opportunity of carrying out its undertaking to review the whole field of succession and the administration of deceased estates 'in a harmonious and effective manner' as Mr Ndjodze averred. However, the period of three years he requested is inordinately long. Seven years have elapsed since Namibia signed the United



Nations International Convention on the Elimination of all Forms of Racial Discrimination. Consequently, a shorter period of suspension will meet the justice of the case.

In the result, the application succeeds and the following order is made:

1. Sections 18(1), 18(2) and 18(9) of the Native Administration Proclamation 15 of 1928 (the Proclamation) and the regulations made under s 18(9) thereof are declared to be in conflict with the Constitution of Namibia. Parliament is required to remedy the defect by 30 June 2005.
2. Until the defect is remedied, or until the expiration of the time set by this order, whichever be the shorter, ss 18(1) and 18(2) of the Proclamation and the regulations made under s 18(9) of the Proclamation shall be deemed to be valid.
3. For the avoidance of doubt, it is declared that the jurisdiction of the Master of the High Court relating to deceased estates shall be concurrent with the jurisdiction exercised by the magistrates in terms of the express or implied terms of the legislation deemed to be valid in terms of this order.
4. It shall be open to any party to the administration of a deceased estate to request the Master of the High Court to administer the estate in question in terms of the Administration of Estates Act 66 1965, subject to the jurisdictional limit set by s 4 of the Act.
5. Leave is granted to any interested person to approach this Court for a variation of this order in the event of serious administrative or practical problems in implementing any of the terms of the order.
6. The Ministry of Justice is requested to bring the terms of this order to the attention of all magistrates dealing with the administration of estates under the Native Administration Proclamation 15 of 1928 and the regulations promulgated under the Proclamation.
7. The appointment of second respondent as executor in the estate of the late Martha Berendt is set aside.

8. The deed of sale dated 31 May 2002 entered into by and between second and first respondents is set aside.
9. First respondent is directed to produce the original deed of transfer No T5434/02, in terms of which the immovable property concerned was registered in the name of first respondent and to hand the said deed to fifth respondent to record and give effect to this order.
10. Fifth respondent is directed to make such entries in the deed of transfer No T5434/02 and in the books of the registrar of deeds, Windhoek, as may be necessary to record and give effect to this order.
11. It is declared that the Administration of Estates Act 66 of 1965 as amended (the Act) shall apply to the estate of the late Martha Berendt and fourth respondent is directed to supervise the administration of the estate in terms of the Act.
12. As all the respondents were entitled to resist this application, there will be no order for costs.
13. The first respondent's counter claim for eviction of the applicants and his claim for damages for occupation of the house by the applicants are dismissed with no order for costs.

Applicants' legal practitioners: Legal Assistance Centre

First respondent's legal practitioners: A Vaatz& Partners

3rd, 4th, 6th and 7th respondent's legal practitioners: Government Attorney

**Estates and Succession Amendment Act, 2005 (Act No. 15 of 2005)**

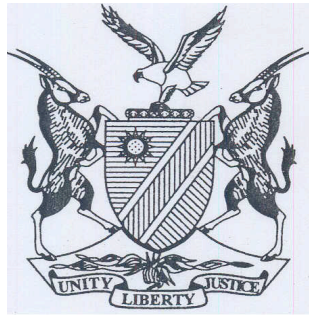

**GOVERNMENT GAZETTE**  
OF THE  
**REPUBLIC OF NAMIBIA**

---

N\$2.00

WINDHOEK - 29 December 2005

No. 3566

---

CONTENTS

GOVERNMENT NOTICE

*Page 1*

No. 186 Promulgation of Estates and Succession Amendment Act, 2005 (Act No. 15 of 2005), of the Parliament

---

**Government Notice**

---

No. 186

**OFFICE OF THE PRIME MINISTER**

2005

PROMULGATION OF ACT  
OF PARLIAMENT

The following Act which has been passed by the Parliament and signed by the President in terms of the Namibian Constitution is hereby published in terms of Article 56 of that Constitution.

No. 15 of 2005: Estates and Succession Amendment Act, 2005.

**Act No. 15, 2005                    ESTATES AND SUCCESSION AMENDMENT ACT, 2005****EXPLANATORY NOTE:**

----- Words underlined with a solid line indicate insertions in existing provisions.

[        [Words in bold type in square brackets indicate omissions from existing provisions.

---

**ACT**

**To**        **repeal certain provisions of the Native Administration Proclamation, 1928 and the whole of the Administration of Estates (Rehoboth Gebiet) Proclamation, 1941 the effect of which are to provide in an unfair discriminatory manner for different systems of dealing with the administration of estates of certain deceased persons based on race or ethnic origin; to make provision that the Administration of Estates Act, 1965 governs the administration of the liquidation and distribution of all deceased estates, whether testate or intestate; and to provide for matters connected therewith.**

*(Signed by the President on 23 December 2005)*

**BE IT ENACTED** by the Parliament of the Republic of Namibia, as follows:

**Repeal of section 18 of the Native Administration Proclamation, 1928 (Proclamation No. 15 of 1928)**

1.        (1)        Section 18 of the Native Administration Proclamation, 1928 is amended by the repeal of subsections (1), (2), (9) and (10).

(2) Despite the repeal of the provisions referred to in subsection (1), the rules of intestate succession that applied by virtue of those provisions before the date of their repeal continue to be of force in relation to persons to whom the relevant rules would have been applicable had the said provisions not been repealed.

**Repeal of Administration of Estates (Rehoboth Gebiet) Proclamation, 1941 (Proclamation No 36 of 1941)**

2. (1) The Administration of Estates (Rehoboth Gebiet) Proclamation, 1941 is repealed.

(2) Despite the repeal of the Proclamation referred to in subsection (1), the rules of intestate succession that applied by virtue of Schedule 2 of that Proclamation before the date of its repeal continue to be of force in relation to persons to whom the relevant rules would have been applicable had the said Proclamation not been repealed.

(3) The repeal of the Proclamation referred to in subsection (1) does not affect the validity of a will which but for such repeal would be valid.

**Application of Administration of Estates Act, 1965 and transitional provisions**

3.        (1)        Subject to subsection (2), the administration of the liquidation and distribution of all deceased estates, whether testate or intestate, of persons who died on

**Act No. 15, 2005 ESTATES AND SUCCESSION AMENDMENT ACT, 2005**

or after the date of commencement of this Act, are governed by the Administration of Estates Act, 1965 (Act No. 66 of 1965).

(2) The estate of a person who died before the date of commencement of this Act which was administered, immediately before that date, in terms of the Native Administration Proclamation, 1928 or the Administration of Estates (Rehoboth Gebiet) Proclamation, 1941, must be liquidated and distributed and any matter relating to the liquidation and distribution of such estate must be dealt with as if this Act had not been passed.

(3) Despite subsection (2), if, in the case of an estate referred to in that subsection the liquidation and distribution of which immediately before the commencement of this Act was being administered in terms of the Native Administration Proclamation, 1928 or the Administration of Estates (Rehoboth Gebiet) Proclamation, 1941 and which has not been completed by the date of such commencement, any person having an interest in the estate in writing requests the Master of the High Court to administer the estate in question in terms of the Administration of Estates Act, 1965, the Master must

- (a) in writing request the magistrate in charge of the supervision of the estate in question to transfer such estate to the Master's supervision and control; and
- (b) upon receipt of the relevant documents and information pertaining to the estate in question exercise jurisdiction in respect of the estate in terms of the Administration of Estates Act, 1965.

(4) Upon receipt of a request of the Master in terms of subsection (3)(a), the magistrate concerned must forthwith provide the Master with all documents pertaining to the estate in question which have been lodged with the magistrate or which are under his or her control as well as a written report in relation to any matter concerning the estate of which the magistrate has knowledge and which is reasonably required for assisting the Master in the performance of any function under the Administration of Estates Act, 1965 in relation to the estate.

**Amendment of Administration of Estates Act, 1965**

4. The Administration of Estates Act, 1965 (Act No. 66 of 1965) is amended by the insertion after section 4 of the following section:

**"Minister may assign functions of Master to magistrates**

- 4A.** (1) The Minister after consultation with the Master and the Chief of lower courts, may by notice in the *Gazette* -
- (a) determine that any powers or functions vested in or assigned to the Master by this Act, as are specified in the notice, be vested in and assigned also to a magistrate for the purpose of assisting in the performance of the Master's functions under the Act in relation to estates contemplated in section 18(3); and
  - (b) determine conditions or restrictions in relation to the exercise of an powers or performance of any functions by magistrates referred to in paragraph (a) and prescribe procedures to be followed in connection therewith.

**Act No. 15, 2005            ESTATES AND SUCCESSION AMENDMENT ACT, 2005**

- (2) A magistrate must
- (a) exercise the powers and perform the functions referred to in subsection (1) subject to any conditions and restrictions and in accordance with any procedures as may be prescribed under that subsection and with due regard to any guidelines as the Master may issue; and
  - (b) provide the Master with any information as the Master may require from the magistrate in relation to any estate the administration of which is being supervised by the magistrate.
- (3) The Master is not divested of or discharged from any power or duty in terms of this Act in relation to an estate the administration of which is being supervised by a magistrate by virtue of this section and may at any time require from any magistrate to transfer any such estate to the Master's supervision and control.
- (4) A magistrate must
- (a) comply with a request for information by the Master in terms of subsection (2)(b); and
  - (b) upon receipt of a request from the Master to transfer any estate to the supervision and control of the Master, provide the Master with all documents pertaining to the estate which have been lodged with the magistrate or are under his or her control as well as a written report in relation to any matter concerning the estate of which the magistrate has knowledge and which is reasonably required for assisting the Master in the performance of any function under this Act in relation to the estate.”

**Short title**

5. This Act is called the Estates and Succession Amendment Act, 2005.

INTESTATE SUCCESSION ORDINANCE 12 OF 1946

ORDINANCE

**To provide for the amendment of the law relating to succession.**

1. (1) The surviving spouse of every person who after the commencement of this Ordinance dies either wholly or partly intestate, is hereby declared to be an intestate heir of the deceased spouse according to the following rules:-

- (a) if the spouses were married in community of property and if the deceased spouse leaves any descendant who is entitled to succeed *ab intestato*, the surviving spouse shall succeed to the extent a child's share or to so much as together with the surviving spouse's share in the joint estate, does not exceed R50 000.00 in value (whichever is the greatest);
- (b) if the spouses were married out or community of property and if the deceased spouse leaves any descendant who is entitled to succeed *ab intestato*, the surviving spouse shall succeed to the extent of a child's share or to so much as does not exceed R50 000.00 in value (whichever is the greatest);
- (c) if the spouses were married either in or out or community of property, and the deceased spouse leaves no descendant who is entitled to succeed *ab intestato*, but leaves a parent or a brother or a sister (whether of the full or half blood) who is entitled so to succeed, the surviving spouse shall succeed to the extent of a half share or to so much as does not exceed R50 000.00 in value (whichever is the greater);
- (d) in any case not covered by paragraph (a), (b), or (c) the surviving spouse shall be the sole intestate heir.

[Sub-section 1 amended by sect 1 of Ordinance 6 of 1963 and further amended by sect 1 of Act 15 of 1982.]

(2) For the purposes of this Ordinance any relationship by adoption under the provisions of the Adoption of Children Ordinance, 1927 (Ordinance 10 of 1927), shall be equivalent to blood relationship.

2. This Ordinance may be cited as the Intestate Succession Ordinance, 1946.

**Political Ordinance of 1 April 1580, Articles 19 – 29**

Article 19:

Regarding inheritances, the States are hereby withdrawing and repealing all written rights, customs and laws applicable in the States and countries of Holland and Friesland concerned within testate deaths or where a person dies without a last will. These regulations concern all movable and immovable properties. From now on only these new Articles that follow will be applicable.

Article 20:

Firstly, children and other direct descendants *ad infinitum* succeed by representation or *per stirpes*.

Article 21:

If both parents of the intestate be alive, they succeed absolutely upon failure of children and descendants of remoter degree.

Article 22:

If one or both of the parents be dead, the succession must go absolutely to the intestate's brothers and sisters and their children and grandchildren *per stirpes* or by representation.

Article 23:

Half-brothers and half-sisters, their children and grand-children, and other collateral relations who were related to the intestate through one parent only, take with the "half-hand" and according to the degree of consanguinity in which they stood related to him.

Article 24:

Failing all descendants, father, mother, brothers and sisters and their children and grandchildren, the uncles and aunts, and their children, take *per stirpes*.

Article 25:

But, however, if grandfather and grandmother on the one side be both alive, they succeed, as regards property derived from that side, in preference to the uncles and aunts and their children descended from these grandparents of the intestate; but these grandparents do not oust the intestate's brothers and sisters as regards such property.

Article 26:



In the case of own parents or other ascendants when the bed has been severed and one alone survives, the latter does not participate in the succession.

Article 27:

The estate of the deceased shall go to his next of kin on the father's and mother's side, and be divided into two equal parts, without any distinction being made whether the deceased inherited more from his father than from his mother, or vice versa.

Now, the context clearly shows that this section was intended to apply to the case in which the deceased died without either descendants or parents him surviving. In such a case the general rule is laid down that the succession shall be *per line as*, one-half of the estate going to the next of kin on the paternal side, and the other half to the next of kin on the maternal side.

Article 28:

Representation shall not be admitted among collaterals, further than the grandchildren of brothers and sisters, and the children of uncles and aunts, inclusively, and all other collaterals, being the next of kin of the deceased, and in equal degrees, shall take per capita, to the exclusion of all who are in a more remote degree of consanguinity, the nearest excluding those more remote.

Article 29:

Children who have received from their parents any money or property given as a marriage gift or for the purpose of benefiting the children in business affair or otherwise in such matters, must collate or bring into the estate of their parents such money or property before sharing the estate with the other successors. The amount to be collated is the value of the donation at the time it was made, if the property had not had a valuation placed upon it; but if such was the case, the valuation must be followed in collating. The property must then be divided into equal parts, one half going to the surviving spouse, and the other half the heirs take: This will also take place in the first, second and third generations. The foregoing rules regarding succession and collation rule when no contrary provisions exist by virtue of a "testament, ante nuptial contract, deeds executed before the Orphan Chamber, or any other contracts;"

**Interpretation of 13 May 1594**

This Interpretation essayed to elucidate the difficult and doubtful points that arose in regard to the terms of the Political Ordinance: Half-brothers and half-sisters must succeed with the half-hand if both of the parents of the intestate predeceased him; that is, the full brothers and sisters or their children or grandchildren by representation must take one-half of the estate, whilst the other half they share equally with the half-brothers and half-sisters, or their children or grandchildren by representation, who are related to the intestate on the one side only. But if that parent alone is dead through whom the half-brothers and half-sisters have their claim upon the intestate, the other parent of the intestate being still living, they, or their children or grandchildren by representation, succeed with a full hand: not otherwise, however. The same applies to the case of other collaterals, in their various degrees, when related to the intestate on the one side only. [Compare, however, the rule stated below, regarding collaterals related through other ascendants.] Further descendants of brothers and sisters, in the fifth and remoter degrees, rank before grandparents and remoter ascendants, as also uncles and aunts, their children and grandchildren, and further descendants, and they succeed per capita, not per stirpes. If, on the one side, only one of the ascendants [as in Art 26, the application hereof to parents is nullified by the Charter of 1661] be alive, neither he, nor any persons, related to the intestate through the deceased spouse alone, will succeed to the intestate. The division of the intestate's estate *per line* as, to the father's and the mother's side equally, occurs only when the parents are both dead. And the above rules must govern.

**Octrooi of 10 January 1661**

In applying the above laws to the Indies, this Charter partially altered Art 26 of the Ordinance: When the marriage of the intestate's parents has been dissolved, and only one of them is living, he or she will succeed to the intestate along with the brothers and sisters, whether of the full or the half blood, or their children or grandchildren by representation. That is, the surviving parent takes one-half, and the brothers and sisters, or their children or grandchildren by representation, take the other half; but the half relations in order to succeed must be related to the intestate through his deceased parent. If there be neither brothers nor sisters alive, their children or grandchildren by representation will in like manner take one half, the parent taking the other. If there be neither, brothers, sisters, their children nor grandchildren alive, the surviving parent of the intestate will succeed to the estate absolutely, and exclude all collaterals. Land, houses and other immovable property must follow the law and customs of the Provinces, Districts of places where it is situated.

## Second Schedule.

## RULES OF INTESTATE SUCCESSION APPLICABLE TO THE ESTATES OF MEMBERS OF THE REHOBOTH BASTARD COMMUNITY.

When in any estate no valid will is left by the deceased the assets thereof shall be distributed among the heirs in the manner following:

- (1) (a) Where the deceased is survived by a wife or husband and children.

Half of the estate shall devolve upon the surviving spouse, and the other half upon the surviving spouse and the children in equal shares.

Children of pre-deceased children shall succeed to the shares of their deceased parent per stirpes.

- (b) Where the deceased is survived only by children.

The whole estate shall devolve upon the children in equal shares, the children of predeceased children succeeding to the shares of their deceased parent per stirpes.

- (c) Where the deceased leaves only a wife or husband.

Half of the estate shall devolve upon the surviving spouse, who shall also be entitled to one-third of the remaining half. The remaining two thirds of the remaining half shall devolve in equal shares upon the mother and father of the deceased, or if there be only a mother or a father surviving, such mother or father shall receive the whole of the remaining two-thirds of one half of the estate. Should both parents of the deceased have pre-deceased him, then the remaining two-thirds of one half of the estate shall devolve in equal shares upon the brothers and sisters of the deceased. Provided that in any case the surviving spouse of the deceased shall be entitled to the full usufruct of all the assets in the estate until such time as he or she dies or re-marries.

- (d) Where the deceased leaves no surviving spouse or children.

The entire estate shall devolve upon the family of the deceased in accordance with the rules set out in paragraph (c) hereof.

- (e) In cases not falling under paragraphs (a), (b), (c) or (d).

The matter shall be placed before the Magistrate and Advisory Council, who may give such directions in regard to the disposal of the assets as may seem to them proper. Provided that an appeal against any such direction shall lie in the manner provided by sections *twenty-five* and *twenty-six* of the Proclamation.

- (2) Any illegitimate child shall possess the full right of succession to any estate left by its mother, but shall possess no right of succession to the estate of its father except by way of testamentary disposition.